

**MTS400P  
MPEG Test System  
Specifications and Performance Verification  
Technical Reference**



077-0202-01



**MTS400P  
MPEG Test System  
Specifications and Performance Verification  
Technical Reference**

Copyright © Tektronix. All rights reserved. Licensed software products are owned by Tektronix or its subsidiaries or suppliers, and are protected by national copyright laws and international treaty provisions.

Tektronix products are covered by U.S. and foreign patents, issued and pending. Information in this publication supersedes that in all previously published material. Specifications and price change privileges reserved.

TEKTRONIX and TEK are registered trademarks of Tektronix, Inc.

## **Contacting Tektronix**

Tektronix, Inc.  
14200 SW Karl Braun Drive  
P.O. Box 500  
Beaverton, OR 97077  
USA

For product information, sales, service, and technical support:

- In North America, call 1-800-833-9200.
- Worldwide, visit [www.tektronix.com](http://www.tektronix.com) to find contacts in your area.

## Warranty

Tektronix warrants that this product will be free from defects in materials and workmanship for a period of one (1) year from the date of shipment. If any such product proves defective during this warranty period, Tektronix, at its option, either will repair the defective product without charge for parts and labor, or will provide a replacement in exchange for the defective product. Parts, modules and replacement products used by Tektronix for warranty work may be new or reconditioned to like new performance. All replaced parts, modules and products become the property of Tektronix.

In order to obtain service under this warranty, Customer must notify Tektronix of the defect before the expiration of the warranty period and make suitable arrangements for the performance of service. Customer shall be responsible for packaging and shipping the defective product to the service center designated by Tektronix, with shipping charges prepaid. Tektronix shall pay for the return of the product to Customer if the shipment is to a location within the country in which the Tektronix service center is located. Customer shall be responsible for paying all shipping charges, duties, taxes, and any other charges for products returned to any other locations.

This warranty shall not apply to any defect, failure or damage caused by improper use or improper or inadequate maintenance and care. Tektronix shall not be obligated to furnish service under this warranty a) to repair damage resulting from attempts by personnel other than Tektronix representatives to install, repair or service the product; b) to repair damage resulting from improper use or connection to incompatible equipment; c) to repair any damage or malfunction caused by the use of non-Tektronix supplies; or d) to service a product that has been modified or integrated with other products when the effect of such modification or integration increases the time or difficulty of servicing the product.

THIS WARRANTY IS GIVEN BY TEKTRONIX WITH RESPECT TO THE PRODUCT IN LIEU OF ANY OTHER WARRANTIES, EXPRESS OR IMPLIED. TEKTRONIX AND ITS VENDORS DISCLAIM ANY IMPLIED WARRANTIES OF MERCHANTABILITY OR FITNESS FOR A PARTICULAR PURPOSE. TEKTRONIX' RESPONSIBILITY TO REPAIR OR REPLACE DEFECTIVE PRODUCTS IS THE SOLE AND EXCLUSIVE REMEDY PROVIDED TO THE CUSTOMER FOR BREACH OF THIS WARRANTY. TEKTRONIX AND ITS VENDORS WILL NOT BE LIABLE FOR ANY INDIRECT, SPECIAL, INCIDENTAL, OR CONSEQUENTIAL DAMAGES IRRESPECTIVE OF WHETHER TEKTRONIX OR THE VENDOR HAS ADVANCE NOTICE OF THE POSSIBILITY OF SUCH DAMAGES.

[W2 – 15AUG04]



---

# Table of Contents

|  |      |
|--|------|
| General Safety Summary .....               | iv   |
| Preface .....                              | vii  |
| Manual Structure.....                      | vii  |
| Related User Documents.....                | vii  |
| Manual Conventions.....                    | viii |
| Introduction .....                         | ix   |
| Performance Check Interval .....           | ix   |
| Specifications .....                       | 1-1  |
| Software Protection.....                   | 1-1  |
| Performance Conditions .....               | 1-1  |
| Functional Specifications .....            | 1-2  |
| Electrical Specifications.....             | 1-2  |
| Mechanical (Physical) Characteristics..... | 1-12 |
| Environmental Characteristics .....        | 1-13 |
| Performance Verification .....             | 2-1  |
| Connecting to a Network .....              | 2-1  |
| Required Equipment.....                    | 2-6  |
| MTS400P Test Record .....                  | 2-7  |
| Procedures .....                           | 2-7  |

## List of Figures

|   |      |
|---|------|
| Figure 1-1: Timing diagram of the SPI and universal parallel/serial interfaces .....                | 1-9  |
| Figure 2-1: Pin connections for a crossover Ethernet cable .....                                    | 2-1  |
| Figure 2-2: Network Connections window .....  | 2-2  |
| Figure 2-3: Local Area Connection Status dialog box .....   | 2-3  |
| Figure 2-4: Local Area Connection Properties dialog box.....  | 2-3  |
| Figure 2-5: Internet Protocol (TCP/IP) Properties dialog box.....                                   | 2-4  |
| Figure 2-6: Equipment connection for verifying the internal clock output level.....                 | 2-8  |
| Figure 2-7: Equipment connection for verifying the internal clock frequency .....                   | 2-9  |
| Figure 2-8: Equipment connection for verifying the SPI interface .....                              | 2-10 |
| Figure 2-9: Equipment connections for verifying the external clock/reference and trigger inputs.... | 2-14 |
| Figure 2-10: Equipment connection for verifying the IEEE1394b interface .....                       | 2-17 |
| Figure 2-11: Equipment connection for verifying output signal-SMPTE310M interface .....             | 2-18 |
| Figure 2-12: Equipment connection for verifying the ASI play operation.....                         | 2-20 |
| Figure 2-13: Equipment connection for verifying the ASI record operation .....                      | 2-21 |
| Figure 2-14: Equipment connection for verifying the recorded file-ASI interface.....                | 2-23 |
| Figure 2-15: Equipment connection for verifying the SMPTE310M play operation .....                  | 2-24 |
| Figure 2-16: Equipment connection for verifying the SMPTE310M record operation.....                 | 2-26 |
| Figure 2-17: Equipment connection for verifying the recorded file-ASI interface.....                | 2-27 |
| Figure 2-18: Equipment connection for verifying the SPI record operation.....                       | 2-29 |
| Figure 2-19: Equipment setup for Option GbE performance verification.....                           | 2-36 |
| Figure 2-20: IP Flow selection.....   | 2-41 |
| Figure 2-21: Clock dialog box .....   | 2-43 |



## List of Tables

|  |      |
|--|------|
| Table 1-1: Functional specifications.....  | 1-2  |
| Table 1-2: Mainframe.....  | 1-2  |
| Table 1-3: SMPTE310M/ASI/SPI interface (Option 07).....                            | 1-7  |
| Table 1-4: GigE interface card - general characteristics.....                      | 1-10 |
| Table 1-5: GigE interface card - Ethernet electrical port.....                     | 1-10 |
| Table 1-6: GigE interface card - ASI input.....                                    | 1-11 |
| Table 1-7: GigE interface card - ASI output.....                                   | 1-11 |
| Table 1-8: GigE interface card - SMPTE310M input (loop-through to ASI output)..... | 1-12 |
| Table 1-9: Mechanical characteristics.....   | 1-12 |
| Table 1-10: Environmental characteristics.....                                     | 1-13 |
| Table 2-1: Equipment required for performance verification.....                    | 2-6  |
| Table 2-2: MTS400P test record.....  | 2-7  |

## General Safety Summary

Review the following safety precautions to avoid injury and prevent damage to this product or any products connected to it.

To avoid potential hazards, use this product only as specified.

*Only qualified personnel should perform service procedures.*

While using this product, you may need to access other parts of a larger system. Read the safety sections of the other component manuals for warnings and cautions related to operating the system.

### To Avoid Fire or Personal Injury

**Use Proper Power Cord.** Use only the power cord specified for this product and certified for the country of use.

**Ground the Product.** This product is indirectly grounded through the grounding conductor of the mainframe power cord. To avoid electric shock, the grounding conductor must be connected to earth ground. Before making connections to the input or output terminals of the product, ensure that the product is properly grounded.

**Observe All Terminal Ratings.** To avoid fire or shock hazard, observe all ratings and markings on the product. Consult the product manual for further ratings information before making connections to the product.

The inputs are not rated for connection to mains or Category II, III, or IV circuits.

**Power Disconnect.** The power cord disconnects the product from the power source. Do not block the power cord; it must remain accessible to the user at all times.

**Do Not Operate Without Covers.** Do not operate this product with covers or panels removed.

**Do Not Operate With Suspected Failures.** If you suspect that there is damage to this product, have it inspected by qualified service personnel.

**Avoid Exposed Circuitry.** Do not touch exposed connections and components when power is present.

**Use Proper Fuse.** Use only the fuse type and rating specified for this product.

**Do Not Operate in Wet/Damp Conditions.**

**Do Not Operate in an Explosive Atmosphere.**

**Keep Product Surfaces Clean and Dry.**

**Provide Proper Ventilation.** Refer to the manual's installation instructions for details on installing the product so it has proper ventilation.

**Terms in this Manual** These terms may appear in this manual:



**WARNING.** *Warning statements identify conditions or practices that could result in injury or loss of life.*



**CAUTION.** *Caution statements identify conditions or practices that could result in damage to this product or other property.*

**Symbols and Terms on the Product**

These terms may appear on the product:

- DANGER indicates an injury hazard immediately accessible as you read the marking.
- WARNING indicates an injury hazard not immediately accessible as you read the marking.
- CAUTION indicates a hazard to property including the product.

The following symbol(s) may appear on the product:



CAUTION  
Refer to Manual



Protective Ground  
(Earth) Terminal



Standby



# Preface

This manual lists the published specifications for the MTS400P Portable MPEG Test System and provides a procedure for verifying the performance of the instrument.








## Manual Structure

This manual is divided into following sections:

- *Specifications* Contains a description of the MTS400P and characteristics that apply to it.
- *Performance Verification* Contains procedures for confirming that an MTS400P functions properly and meets warranted characteristics.

Sections containing procedures also contain introductions to those procedures. Be sure to read these introductions because they provide information needed to do the service correctly and efficiently.

## Related User Documents

| Item  | Purpose   | Location   |
|---|---|--|
| MTS400P Quick Start User Manual (071-2610-xx English, 071-2611-xx Japanese) | Provides installation and high-level operational overviews                          |  +  + <br>www.Tektronix.com |
| MTS400P Service Manual (077-0201-xx)  | Optional manual supporting module-level servicing of the instrument                 |  + <br>www.Tektronix.com   |
| MTS400P Declassification and Security Instructions (077-0209-xx)            | Provides instructions for removing your proprietary information from the instrument | <br>www.Tektronix.com   |
| MTS400P Release Notes (077-0210-xx)   |   | <br>www.Tektronix.com   |

## Manual Conventions

This manual uses certain conventions with which you should become familiar.

Some sections of the manual contain procedures for you to perform. To keep those instructions clear and consistent, this manual uses the following conventions:

- Names of front panel controls and menus appear in the same case (initial capitals, all uppercase, and so forth) in the manual as is used on the MTS400P front panel and menus.
- Instruction steps are numbered unless there is only one step.
- **Bold** text refers to specific interface elements that you are instructed to select, click, or clear.

Example: Press the **Menu** button to open the **File** menu.

- *Italic* text refers to document names or sections. Italics are also used in NOTES, CAUTIONS, and WARNINGS.

Example: Generally, the performance check described in the *Performance Verification* section, should be done every twelve months. In addition, a performance check is recommended after module replacement.

---

# Introduction

This manual contains information needed to properly service the MTS400P Portable MPEG Test System, as well as general information critical to safe and effective servicing.

To prevent personal injury or damage to the MTS400P, consider the following before attempting service:

- The procedures in this manual should be performed only by a qualified service person.
- Read the General Safety Summary and the Service Safety Summary.

When using this manual for servicing, be sure to follow all warnings, cautions, and notes.

## Performance Check Interval

Generally, the performance check described in the *Performance Verification* section, should be done every twelve months. In addition, a performance check is recommended after module replacement.

If the MTS400P does not meet performance criteria, repair is necessary.





---

# Specifications

Tables 1 through 13 list the functional, electrical, mechanical, and environmental characteristics of the MTS400P. All listed specifications are guaranteed unless labeled “typical”. Typical specifications are provided for your convenience but are not guaranteed.

## Software Protection

The MTS400P software options require that a software key, and beginning with V10.1, an OptionDongle be installed so that the purchased set of options can be accessed.



**CAUTION.** *The software key/OptionDongle must be installed on the instrument before the MTS400P software application will operate.*

---

The software key is the character string that is entered into the Option Update Key string field. Beginning with V10.1, an OptionDongle is also provided. The OptionDongle is a small hardware device that is available in parallel port form. The software key and the OptionDongle work together; the software polls the OptionDongle at the beginning of the application and during the Play and Record to verify the option coding. The type of software key used by your test system is determined at the time of the original product order.

Any printer compatible with the installed operating system can be connected to the unit through the parallel port version of the OptionDongle.

## Performance Conditions

The electrical characteristics listed on the following pages are valid under the following conditions:

- The MTS400P must be in an environment where the temperature, altitude, humidity, and vibration conditions are within the operating limits. (See Table 1-10.)
- The MTS400P must have a warm-up period of at least 20 minutes.
- The MTS400P must be operating at an ambient temperature between +5 °C to +40 °C, unless otherwise noted.

## Functional Specifications

Table 1-1: Functional specifications

| Characteristics      | Descriptions    |   |
|----------------------|-----------------|---|
| System configuration | System OS       | Windows XP Professional   |
|                      | CPU             | 1.3 GHz   |
|                      | System memory   | 1GB   |
|                      | Display         | 6.3 inch, XGA (1024 x 768), Windows Control Panel setting is SVGA (800 x 600) |
|                      | Hard disk drive | 250 GB  |

## Electrical Specifications

Table 1-2: Mainframe

| Characteristics                | Description   |
|--------------------------------|---|
| Maximum output rate            |   |
| Hard disk                      | $\geq 120$ Mbps   |
| RAM                            | $\geq 200$ Mbps   |
| Maximum record rate            |   |
| Hard disk                      | $\geq 120$ Mbps (File size: < 4 GB, just after disk format operation) |
|                                | $\geq 90$ Mbps (File size: 33 GB, just after disk format operation)   |
| RAM                            | $\geq 200$ Mbps   |
| Internal reference clock       |   |
| Frequency                      | 27 MHz $\pm$ 1 ppm  |
| Stability                      | $\pm 0.5$ ppm per year  |
|                                | $\pm 1$ ppm over temperature range                                    |
| External reference/clock input |   |
| Connector type                 | BNC   |
| Input impedance, typical       | 50 $\Omega$   |
| Reference input                |   |
| Frequency                      | 8.129698 MHz, 10 MHz, 27 MHz  |
| Input level, typical           | Sine wave: $0 \pm 6$ dBm  |
|                                | Square wave: 0.5 Vp-p to 3.0 Vp-p                                     |
| Clock input                    |   |
| Frequency                      | 160 kHz to 25 MHz (parallel clock)                                    |
|                                | 1.28 MHz to 32 MHz (serial clock)                                     |
| Input level, typical           | 0.5 V to 3.0 V  |

| Characteristics                                      | Description  |
|--|--|
| External trigger input/MISC output                   |  |
| Connector type                                       | BNC  |
| Input impedance, typical                             | 1 k $\Omega$   |
| Threshold level                                      | Rising and falling edges are programmable.   |
| High level   | > 3.5 V (maximum input voltage: 7 V)   |
| Low level  | < 0.8 V  |
| Output level   |  |
| High level   | > 2.2 V (with 50 $\Omega$ termination)   |
| Low level  | < 0.8 V (with 50 $\Omega$ termination)   |
| Output impedance                                     | 50 $\Omega$  |
| PLL  |  |
| Frequency  | 50 MHz to 100 MHz, Locked to reference clock   |
| Output clock   | 50 MHz maximum (serial clock)<br>26.75 MHz maximum (parallel clock)  |
| Output rate  | 214 Mbps maximum<br>64 Kbps minimum  |
| TS clock   |  |
| (Internal and external reference, 27 MHz and 10 MHz) | TS clock = $(X / (2 * Y * Z)) * 27$ MHz<br>15362 < X < 31248<br>1686 < Y < 3376<br>2 $\leq$ Z $\leq$ 65536   |
| (External parallel clock)                            | TS clock = $(X / (2 * Y * Z)) * \text{external parallel clock}$ , 214 MHz maximum<br>15632 < X < 31248<br>1 < Y < 16383<br>2 $\leq$ Z $\leq$ 65536 |
| (External serial clock)                              | TS clock = $(X / (2 * Y * Z)) * \text{external serial clock}$ / 8,32 MHz maximum<br>15632 < X < 31248<br>1 < Y < 16383<br>2 $\leq$ Z $\leq$ 65536  |
| P/N and Jitter (serial clock)                        | < -104 dBc/Hz at 21.455707 MHz +20 kHz (RBW=300 Hz)  |

| Characteristics            | Description  |
|----------------------------|--|
| SPI interface              |  |
| Connector type             | D-sub, 25 pin  |
| Data rate                  | 256 Kbps to 214 Mbps   |
| Pin assignments            | 1: DCLK<br>2: GND<br>3 to 10: DATA 7 to DATA 0<br>11: DVALID<br>12: PSYNC<br>13: Shield<br>14: /DCLK<br>15: GND<br>16 to 23 :/DATA 7 to /DATA 0<br>24: /DVALID<br>25: /PSYNC |
| Output                     |  |
| Output level, typical      | 330 mV to 550 mV (termination: internal 100 Ω, external 100 Ω), bus LVDS with 50 Ω termination   |
| Offset                     | 1.1 V to 1.5 V   |
| Output resistance, typical | 100 Ω, between differential outputs (output off)   |
| Data delay, typical        | ± 5 ns from the falling edge of DCLK.<br>(See Figure 1-1 on page 1-9.)   |
| Input                      |  |
| Input level, typical       | > +100 mV, < -100 mV, (RI+)-(RI-) with 100 Ω termination   |
| Input resistance, typical  | 100 Ω (between differential inputs)  |
| Clock pulse width, typical | $T/2 \pm T/10$ , $T=1/f$ (f=byte clock frequency).<br>(See Figure 1-1 on page 1-9.)  |
| Data hold time, typical    | $T/2 \pm T/10$ , $T=1/f$ (f=byte clock frequency, Data are latched on DCLK rising edge.)<br>(See Figure 1-1 on page 1-9.)  |

| Characteristics | Description  |
|-----------------|--|
| VGA output      |  |
| Connector type  | D-sub, 15 pin  |
| Pin assignments | 1: RED<br>2: GREEN<br>3: BLUE<br>4: NC<br>5: GND<br>6: GND<br>7: GND<br>8: GND<br>9: NC<br>10: GND<br>11: NC<br>12: NC<br>13: HSYNC<br>14: VSYNC<br>15: NC   |
| Printer port    |  |
|                 | Supports SPP (Standard Parallel Port), EPP (Enhanced Parallel Port ), and ECP (Extended Capabilities Port) modes.  |
| Connector type  | D-sub, 25 pin  |
| Pin assignments | 1: STROBE<br>2: D0<br>3: D1<br>4: D2<br>5: D3<br>6: D4<br>7: D5<br>8: D6<br>9: D7<br>10: ACK<br>11: BUSY<br>12: Paper Empty<br>13: SELECT<br>14: AUTOLF<br>15: ERR<br>16: INIT<br>17: SELECT<br>18: GND<br>19: GND<br>20: GND<br>21: GND<br>22: GND<br>23: GND<br>24: GND<br>25: GND |

## Specifications

---

| <b>Characteristics</b>                | <b>Description</b>   |
|---------------------------------------|--|
| USB 2.0 interface                     |  |
| Number of connectors                  | 2  |
| Pin assignments                       | 1: VCC<br>2: -DATA<br>3: +DATA<br>4: GND   |
| LAN interface                         |  |
| 10/100/1000 Base-T Ethernet interface |  |
| Connector type                        | RJ45   |
| Pin assignments                       | 1: MDI_0+<br>2: MDI_0-<br>3: MDI_1+<br>4: MDI_2+<br>5: MDI_2-<br>6: MDI_1-<br>7: MDI_3+<br>8: MDI_3- |
| Serial interface (Com)                |  |
| RS-232C                               |  |
| Connector type                        | D-sub, 9 pin   |
| Pin assignments                       | 1: DCD<br>2: RX<br>3: TX<br>4: DTR<br>5: GND<br>6: DSR<br>7: RTS<br>8: CTS<br>9: RI                  |
| IEEE1394B interface                   |  |
| Compliant                             | IEEE1394B-2002   |
| Pin assignments                       | 1: TPB-<br>2: TPB+<br>3: TPA-<br>4: TPA+<br>5: TPA (R)<br>6: VG<br>7: NC<br>8: VP<br>9: TPB (R)      |

| Characteristics | Description  |
|-----------------|--|
| AC line power   |  |
| Rating Voltage  | 100 VAC to 240 VAC, CAT II   |
| Voltage Range   | 90 VAC to 250 VAC  |
| Frequency Range | 50 Hz to 60 Hz   |
| Maximum power   | 180 VA   |
| Maximum current | 1.3 A  |
| Main fuse data  | 5 A Time-delayed, 250 V (not operator replaceable)<br>2 A Time-delayed, 250 V (not operator replaceable) |

**Table 1-3: SMPTE310M/ASI/SPI interface (Option 07)**

| Characteristics          | Description   |
|--------------------------|---|
| SMPTE310M interface      | Uses common input/output connectors with the ASI interface.       |
| Standard conformance     | SMPTE310M   |
| Connector type           | BNC   |
| Impedance                | 75 $\Omega$   |
| Data rate                | 19.392658 Mbps (8 VSB, 188 bytes packet size)                     |
| Output                   |   |
| Number of outputs        | 1   |
| Output voltage           | 800 mV $\pm$ 10%  |
| Jitter                   | $\leq$ 0.2 UI p-p   |
| Rise/fall time           | 0.4 ns to 5.0 ns (20% to 80%)                                     |
| Frequency range, typical | $\pm$ 3%  |
| Input                    |   |
| Number of inputs         | 1   |
| Input voltage, typical   | 800 mV $\pm$ 10%  |
| Frequency range, typical | $\pm$ 3%  |
| ASI interface            | Uses common input/output connectors with the SMPTE310M interface. |
| Standard conformance     | EN 50083-9 Annex B  |
| Connector type           | BNC   |
| Impedance                | 75 $\Omega$   |
| Data rate                | 256 Kbps to 214 Mbps  |
| Output                   |   |
| Number of outputs        | 1   |
| Output voltage           | 800 mV $\pm$ 10%  |
| Jitter                   | $\leq$ 0.2 UI p-p   |
| Rise/fall time           | $\leq$ 1.2 ns (20% to 80%)  |

**Table 1-3: SMPTE310M/ASI/SPI interface (Option 07) (cont.)**

| Characteristics            | Description  |
|----------------------------|--|
| Return loss                | < -17 dB (5 MHz to 270 MHz) into 75 Ω load   |
| Input                      |  |
| Number of inputs           | 1  |
| Input voltage, typical     | 200 mV to 800 mV   |
| Return loss                | < -17 dB (5 MHz to 270 MHz) into 75 Ω load   |
| SPI interface              |  |
| Connector type             | D-sub, 25 pin  |
| Data rate                  | 256 Kbps to 214 Mbps   |
| Pin assignments            | 1: DCLK<br>2: GND<br>3 to 10: DATA 7 to DATA 0<br>11: DVALID<br>12: PSYNC<br>13: Shield<br>14: /DCLK<br>15: GND<br>16 to 23: /DATA 7 to /DATA 0<br>24: /DVALID<br>25: /PSYNC |
| Input                      |  |
| Input level, typical       | > +100 mV, < -100 mV, (RI+)-(RI-) with 100 Ω termination   |
| Input resistance, typical  | 100 Ω (between differential inputs)  |
| Clock pulse width, typical | $T/2 \pm T/10$ , $T=1/f$ (f=byte clock frequency.) (See Figure 1-1.)   |
| Data hold time, typical    | $T/2 \pm T/10$ , $T=1/f$ (f=byte clock frequency, Data are latched on DCLK rising edge.) (See Figure 1-1.)   |



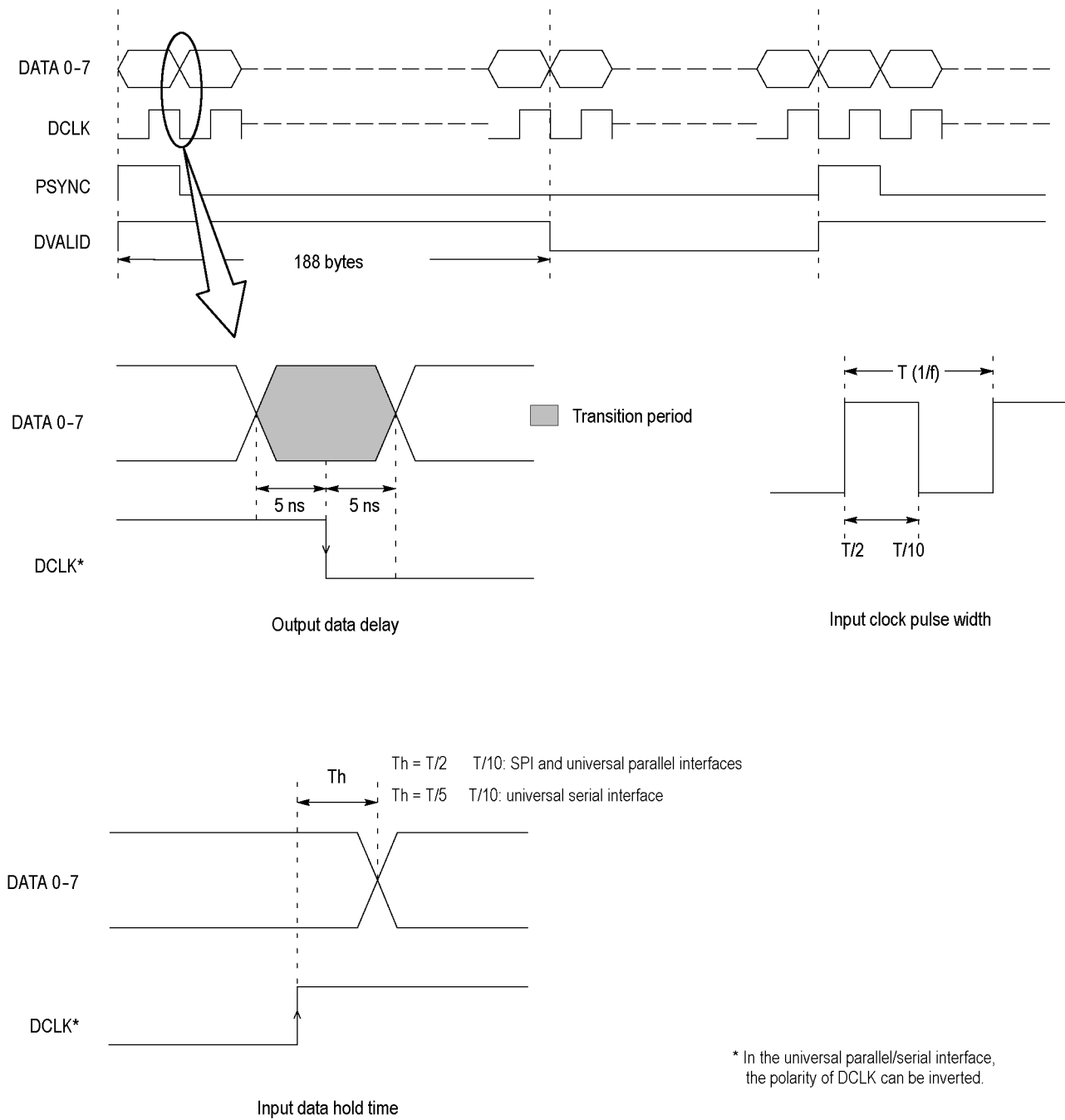


Figure 1-1: Timing diagram of the SPI and universal parallel/serial interfaces

**Table 1-4: GigE interface card - general characteristics**

| Characteristic                | Description  |
|-------------------------------|--|
| Ethernet Port                 | <p>The Ethernet Interfaces supports 1000/100/10 Mbit/s data transmission. The Ethernet Interface to the card will be an IEEE 802.3 compliant 10/100/1000 Ethernet interface supporting 10/100/1000BT, 1000BSX(multi-mode), and 1000BLX(single-mode).</p> <p>Two Ethernet interfaces are available - a copper RJ-45 interface and an MSA (multisource agreement) compliant SFP (Small Form-factor Pluggable) connector. The SFP connector will provide for pluggable optical interfaces. Only one interface, either the copper or optical, will be active at a time for video over IP monitoring. The active interface will be selectable via software control.</p> |
| Transport stream rate over IP | 250 Kbps to 155 Mbps; typical  |

**Table 1-5: GigE interface card - Ethernet electrical port**

| Characteristic            | Description  |
|---------------------------|--|
| Standard                  | 10/100/1000BASE-T IEEE 802.3   |
| Connector Type            | RJ-45  |
| Data Format 10/100 Base T | NRZ  |
| Data Format 1000 Base T   | Trellis encoded, PAM5 symbols full-duplex on 4-pair Cat-5 UTP per IEEE 802.3ab |

**Ethernet optical transmitter - general characteristics**

|                        |  |
|------------------------|--|
| Optical Operating Mode | Single Mode or Multimode                     |
| Connector Type         | Duplex data link MSA compliant SFP connector |
| Standard               | 1000 BASE-X                                  |
| Data Format            | NRZ  |

**Ethernet Optical Transmitter - single mode 1550nm using Tektronix supplied SFP module**

|                             |  |
|-----------------------------|--|
| Output Power                | -2 dBm to +4 dBm; typical                      |
| Center Wavelength - 1550 nm | 1530 nm Min, 1550 nm Typ, 1570 nm Max; typical |
| Total Jitter (Peak-to-Peak) | 170 ps   |
| Extinction Ratio            | 9.0 dBm  |

**Ethernet optical receiver - single mode 1550nm using Tektronix supplied SFP module**

|                     |  |
|---------------------|--|
| Optical Input Power | -26 dBm to -3 dBm, BER 1 X 10 <sup>-12</sup> ; typical |
| Input Wavelength    | 1270 nm = $\lambda$ = 1610 nm                          |

**Ethernet optical transmitter - single mode 1310nm using Tektronix supplied SFP module**

|                             |  |
|-----------------------------|--|
| Output Power                | -11 dBm to -3 dBm; typical                     |
| Center Wavelength - 1310 nm | 1270 nm Min, 1310 nm Typ, 1355 nm Max; typical |
| Total Jitter (Peak-to-Peak) | 170 ps   |
| Extinction Ratio            | 9.0 dBm  |

Table 1-5: GigE interface card - Ethernet electrical port (cont.)

| Characteristic  | Description  |
|---|--|
| <b>Ethernet optical receiver - single mode 1310nm using Tektronix supplied SFP module</b> |  |
| Optical Input Power   | -19 dBm to -3 dBm, BER 1 X 10 <sup>-12</sup> ; typical |
| Input Wavelength  | 1270 nm = $\lambda$ = 1610 nm                          |
| <b>Ethernet optical transmitter - multimode 850nm using Tektronix supplied SFP module</b> |  |
| Output Power  | -9.5 dBm to -2 dBm; typical                            |
| Center Wavelength - 850 nm  | 830 nm Min, 850 nm Typ, 860 nm Ma; typical             |
| Total Jitter (Peak-to-Peak)   | 170 ps   |
| Extinction Ratio  | 9.0 dBm  |
| <b>Ethernet optical receiver - multimode 850nm using Tektronix supplied SFP module</b>    |  |
| Optical Input Power   | -17 dBm to 0 dBm, BER 1 X 10 <sup>-12</sup> ; typical  |
| Input Wavelength  | 770 nm = $\lambda$ = 860 nm                            |

Table 1-6: GigE interface card - ASI input

| Characteristic        | Description                                   |
|-----------------------|---|
| Connector             | BNC   |
| Transport Stream Rate | 250 Kbps to 155 Mbps; typical                 |
| Data Format           | Accepts both Burst and Packet mode ASI format |
| Signal Amplitude      | 2.0 V <sub>p-p</sub> max; 200 mV pk to pk min |
| Termination           | 75 nominal, transformer coupled               |
| Return Loss           | 10 dB min, 5 MHz to 270 MHz                   |
| Link Rate             | 270 Mbaud 100 ppm                             |

Table 1-7: GigE interface card - ASI output

| Characteristic             | Description  |
|----------------------------|--|
| Connector                  | BNC  |
| Impedance                  | 75 nominal, transformer coupled  |
| Transport Stream Rate      | 250 Kbps to 155 Mbps max   |
| Transport Stream Smoothing | Smoothing mechanism for the TS packets before retransmitting packets out on ASI port |
| Signal Amplitude           | 600 mV pk to pk min, 1.0V <sub>p-p</sub> max into a 75 load                          |
| Return Loss                | 10 dB min at 270 MHz   |

**Table 1-8: GigE interface card - SMPTE310M input (loop-through to ASI output)**

| Characteristic   | Description                                  |
|------------------|--|
| Connector        | BNC  |
| Termination      | 75 nominal, transformer coupled              |
| Data Format      | Bi-phase coded. Compliant with SMPTE310M     |
| Input Bit Rate   | 19,392,658.5 bps $\pm$ 2.8 ppm               |
| Signal Amplitude | 2.0V <sub>p-p</sub> max; 200 mV pk to pk min |
| Return Loss      | 10 dB min at 20 MHz                          |

## Mechanical (Physical) Characteristics

**Table 1-9: Mechanical characteristics**

| Characteristics | Description                   |
|-----------------|-------------------------------|
| Net weight      |                               |
| Standard        | Approximately 6 kg (13.2 lb)  |
| Dimensions      |                               |
| Height          | 132 mm (5.1 in), without feet |
| Width           | 214 mm (8.4 in)               |
| Length          | 435 mm (17.1 in)              |

## Environmental Characteristics

Table 1-10: Environmental characteristics

| Characteristics           | Description  |
|---------------------------|--|
| Temperature               |  |
| Operating                 | +5 °C to +40 °C  |
| Non-operating             | -20 °C to +60 °C   |
| Relative humidity         |  |
| Operating                 | 20% to 80% (No condensation)<br>Maximum wet-bulb temperature 29 °C   |
| Non-operating             | 5% to 90% (No condensation)<br>Maximum wet-bulb temperature 29 °C  |
| Altitude                  |  |
| Operating                 | Up to 3 km (approximately 10,000 feet)<br>Maximum operating temperature decreases 1 °C each 300 m above 1.5 km |
| Non-operating             | Up to 15 km (approximately 50,000 feet)  |
| Dynamics                  |  |
| Vibration                 |  |
| Operating                 | 2.65 m/s <sup>2</sup> rms (0.27 Grms), 5 Hz to 500 Hz, 10 min, three axes                                      |
| Non-operating             | 22.3 m/s <sup>2</sup> rms (2.28 Grms), 5 Hz to 500 Hz, 10 min, three axes                                      |
| Shock                     |  |
| Non-operating             | 294 m/s <sup>2</sup> (30 G), half-sine, 11 ms duration   |
| Installation requirements |  |
| Power dissipation         | 100 W maximum. Maximum line current is 1.3 A <sub>rms</sub> at 50 Hz   |
| Surge current             | ≤ 12 A peak for less than 5 line cycles at 25 °C after product has been off for at least 30 seconds            |
| Cooling clearance         |  |
| Top clearance             | 5 cm (2 in)  |
| Side clearance            | 5 cm (2 in)  |
| Rear clearance            | 5 cm (2 in), from the fan guard  |



# Performance Verification

This section provides procedures to verify the performance and functionality of the MTS400P network interface.

## Connecting to a Network

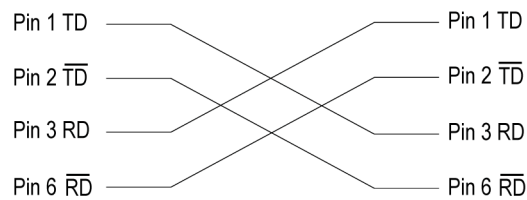
The MTS400P has a LAN (10/100/1000 Base-T) port on the rear panel for Ethernet communications.

This section provides instructions for connecting the MTS400P to a single PC or a network and setting the network parameters for the LAN port.

### Connecting the MTS400P to your PC or MTS400 system

The MTS400P uses the rear-panel LAN port to communicate with a PC or an MTS400 system. Use one of the following methods to connect the MTS400P to your PC or MTS400:

- If you are connecting the MTS400P directly to a single PC, use a crossover Ethernet cable to connect between the LAN port on the MTS400P and the Ethernet port on the PC. If you need to construct your own crossover cable, the following figure shows the pin connections to change on a straight cable to produce a crossover cable.



**Figure 2-1: Pin connections for a crossover Ethernet cable**

- If you are connecting the MTS400P to your local Ethernet network, use a straight Ethernet cable to connect between the LAN port on the MTS400P and the Ethernet hub port of your local network. By connecting to an Ethernet network, you can access the MTS400P using any PC on the network.

## Setting Ethernet Network Parameters

You can set the network parameters for the MTS400P using the Control Panel of Windows XP.

---

**NOTE.** *The following procedure requires that you are familiar with the basics of using the Windows XP operating system. If necessary, review the Windows XP documentation.*

---

Perform the following procedure to set the network parameters for the MTS400P:

1. Connect the keyboard and the mouse provided with the instrument to the USB connectors on the front panel. You can connect them to either of the connectors.
2. Select **File > Minimize** or **File > Exit** to close the MTS400P Portable MPEG Test System. The Windows XP desktop appears.
3. Select **Settings > Control Panel** from the Start menu to display the Control Panel window.
4. Double-click the **Network Connections** icon in the window to display the Network Connections window.

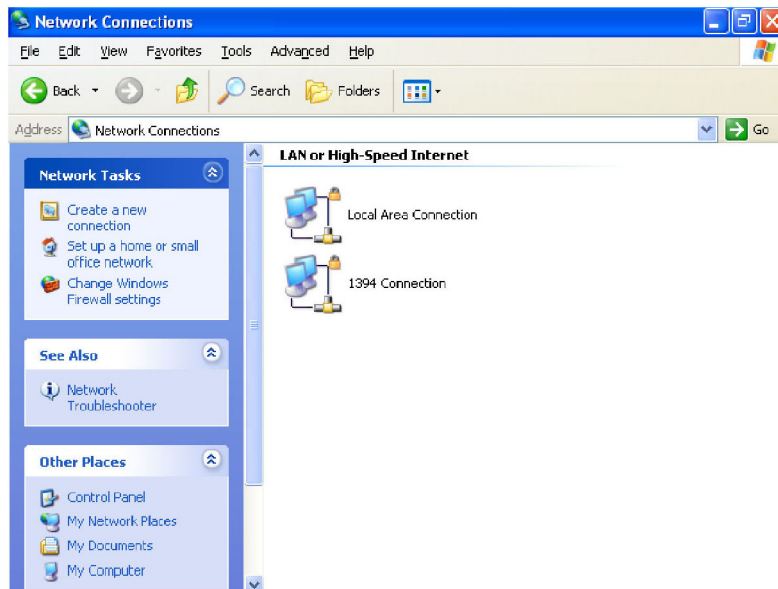


Figure 2-2: Network Connections window



5. Double-click the **Local Area Connection** icon. The Local Area Connection Status dialog box appears.

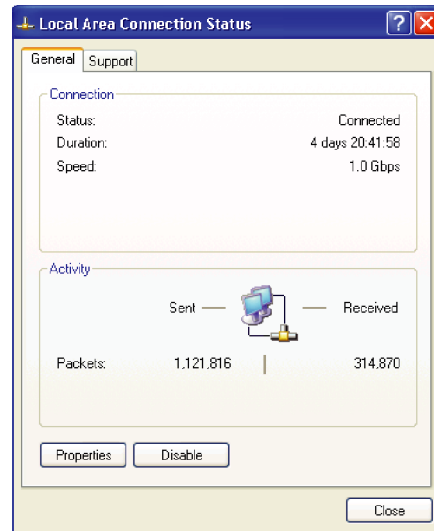


Figure 2-3: Local Area Connection Status dialog box

6. Click the **Properties** button. The Local Area Connection Properties dialog box appears.

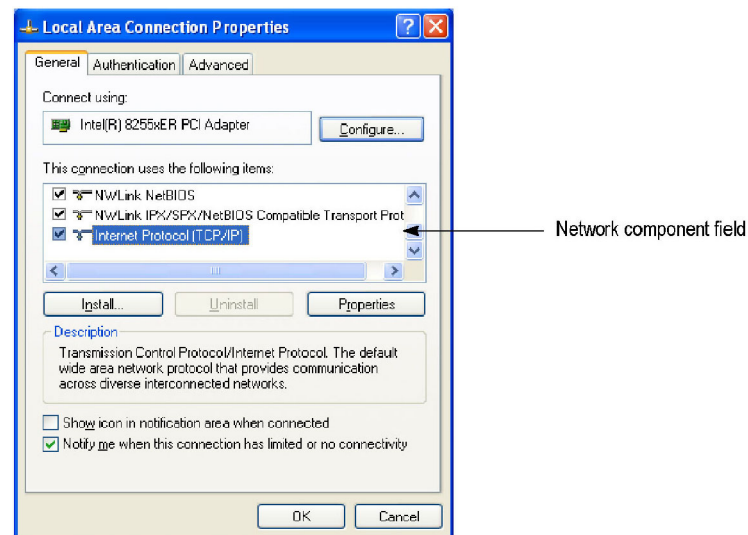
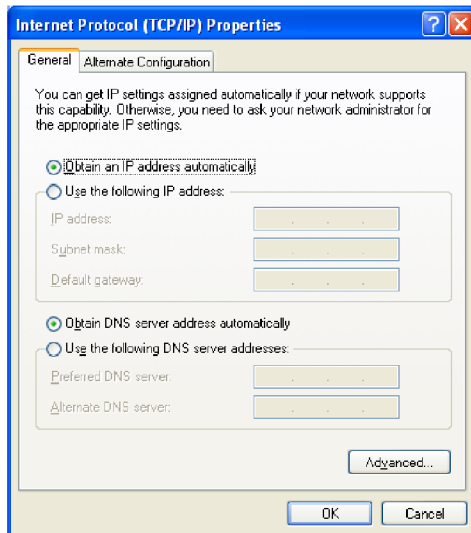


Figure 2-4: Local Area Connection Properties dialog box

7. In the network component field, select **Internet Protocol (TCP/IP)**.

- Click the **Properties** button. The Internet Protocol (TCP/IP) Properties dialog box appears.



**Figure 2-5: Internet Protocol (TCP/IP) Properties dialog box**

The settings in the dialog box depend on whether a DHCP (Dynamic Host Configuration Protocol) server is in the network connected to the MTS400P.

**When the DHCP Server Is in the Network.** If the DHCP server is in the network, perform steps 9 and 10, otherwise skip to step 11.

- In the dialog box, select **Obtain an IP address automatically** and **Obtain DNS server address automatically**.
- Click the **OK** button.

The MTS400P accesses the DHCP server and obtains the addresses automatically when connected to the network.

Refer to the user documentation supplied with your server OS for detailed information about DHCP server functions.

---

**NOTE.** In some network environments, the MTS400P may not be able to obtain the IP address automatically from a DHCP server. In this case, you need to enter the appropriate address value in each submenu item.

---

**When the DHCP Server Is Not in the Network.** If the DHCP server is not in the network, perform the following procedure to set the network parameters.

11. If you connect the MTS400P directly to a single PC or an MTS400 system:
  - a. In the dialog box, select **Use the following IP address**.
  - b. Set the **IP address** parameter to be the same IP address as the PC or the MTS400 system address except for the last digit. The last digit must be different from the last number in the PC or the MTS400 system IP address.
  - c. Set the **Subnet mask** parameter to be the same net mask (subnet mask) used by the PC or the MTS400 system. Do not enter a number if the PC or the MTS400 system does not have a net mask.
  - d. You do not need to enter a **Default gateway** if you are directly connected to a single PC or an MTS400 system.
12. If you connect the MTS400P to your local Ethernet network:
  - a. In the dialog box, select **Use the following IP address**.
  - b. Ask your local network administrator and set the appropriate addresses.



**CAUTION.** *To prevent communication conflicts on your Ethernet network, ask your local network administrator for the correct numbers to enter in the dialog box if you connect the MTS400P to your local Ethernet network.*

---

13. Verify the Ethernet connection by using a ping command from the PC or the MTS400 system.

## Required Equipment

The following table lists the test equipment required to do the performance verification procedures. The table identifies examples of recommended equipment and lists the required precision where applicable. If you substitute other test equipment for the examples listed, the equipment must meet or exceed the listed tolerances.

**Table 2-1: Equipment required for performance verification**

| Item                       | Qty.  | Minimum requirements   | Recommended equipment  |
|----------------------------|-------|--|--|
| Frequency counter          | 1 ea. | Frequency range: 27 MHz Precision: 8 digits or higher              | Agilent Technologies 53181A  |
| MPEG analyzer              | 1 ea. |  | Tektronix MTS430 or MTS400   |
| Function generator         | 1 ea. | Frequency: 40 M clock pattern<br>Amplitude: 3 V Outputs: 2 channel | Tektronix AFG3102  |
| Oscilloscope               | 1 ea. | Bandwidth: 1 GHz or higher   | Tektronix TDS5104B   |
| D-VHS digital recorder     | 1 ea. |  | JVC HM-DH5U  |
| MPEG recorder and player   | 1 ea. |  | Tektronix MTX100A(B) Option 02   |
| Video monitor              | 1 ea. |  | Sony LMD-1420  |
| Probe                      | 1 ea. |  | Tektronix P5050  |
| 75 $\Omega$ signal adapter | 1 ea. | Bandwidth: 1 GHz Amplitude precision: -3 dB                        | Tektronix AMT75  |
| 50 $\Omega$ BNC cable      | 2 ea. | Length: 42 inches  | Tektronix part number 012-0057-01  |
| 75 $\Omega$ BNC cable      | 2 ea. | Length: 42 inches  | Tektronix part number 012-0074-00  |
| Parallel interface cable   | 1 ea. | 25-pin, D-type   | Tektronix part number 012-A220-00 (supplied with the MTS400P)            |
| IEEE1394b cable            | 1 ea. | 9 pin-9 pin  |  |
| IEEE1394 cable             | 1 ea. | 4 pin-4 pin  |  |
| RCA(Ma)-to-BNC(Fe) adapter | 1 ea. |  | Zifor Enterprise BJ-7071   |
| IEEE1394b hard disk drive  | 1 ea. |  | Novac NV-HD352WB and hard disk drive (Tektronix part number 119-7146-00) |

## MTS400P Test Record

Print this page and use it to record the performance test result.

Table 2-2: MTS400P test record

| Serial Number:                        | Cal Date:     | Temperature: | Humidity:     |
|---------------------------------------|---------------|--------------|---------------|
|                                       |               |              |               |
| Performance Test                      | Minimum       | Measured     | Maximum       |
| Internal Clock Frequency <sup>1</sup> | 26.999924 MHz |              | 27.000076 MHz |

<sup>1</sup> Test record limits are based on the SMPTE 310M frequency accuracy requirement.

## Procedures

The following conventions are used in the performance verification procedures:

- Each test lists the characteristic that is being tested and the equipment required to perform the test.
- Each test contains complete setup instructions, which allows you to perform each test individually or in order.
- The equipment connection illustrations are specific to the recommended equipment (equipment nomenclature is labeled). If you are using substitute equipment, the location of your signal connections may vary from those in the illustrations.

---

**NOTE.** Before you begin the performance verification procedures, be sure that the MTS400P is operating in an environment that is within the operating limits. (See Table 1-10 on page 1-13.)

*In addition, the MTS400P and the test equipment must be warmed up for at least 20 minutes to ensure accurate test results.*

---

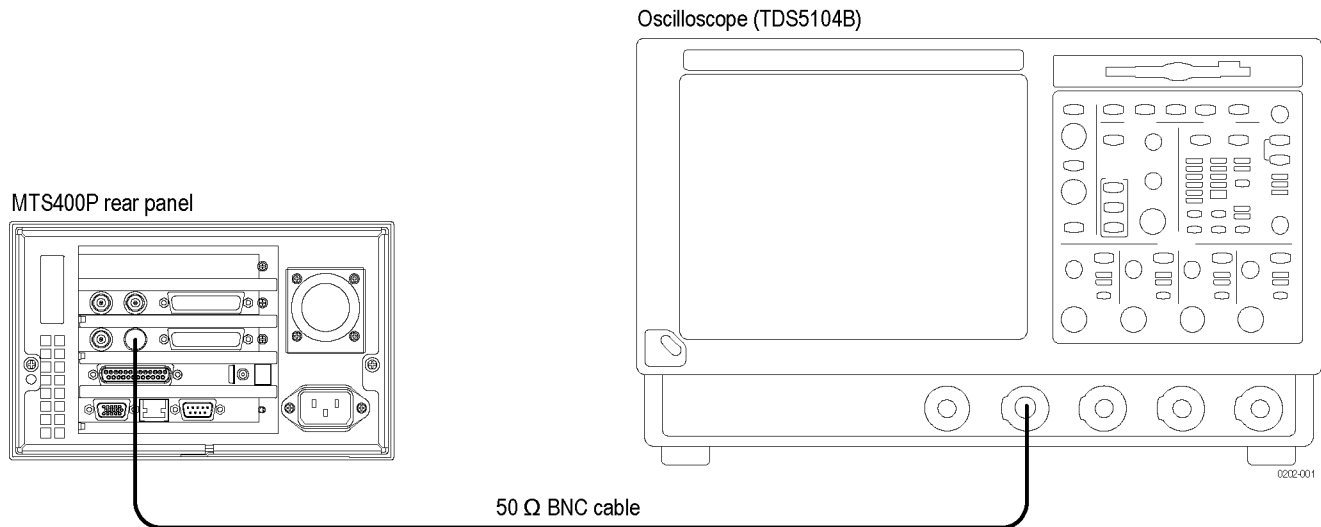
**Internal Clock Output Level and Frequency Accuracy**

This test verifies the internal clock output level and frequency accuracy.

**Equipment required**

- Oscilloscope
- Frequency counter
- 50 Ω BNC cable

1. Use the 50 Ω BNC cable to connect the Trig In/Out connector on the MTS400P to the oscilloscope CH1 input.



**Figure 2-6: Equipment connection for verifying the internal clock output level**

2. Set the oscilloscope as indicated below:

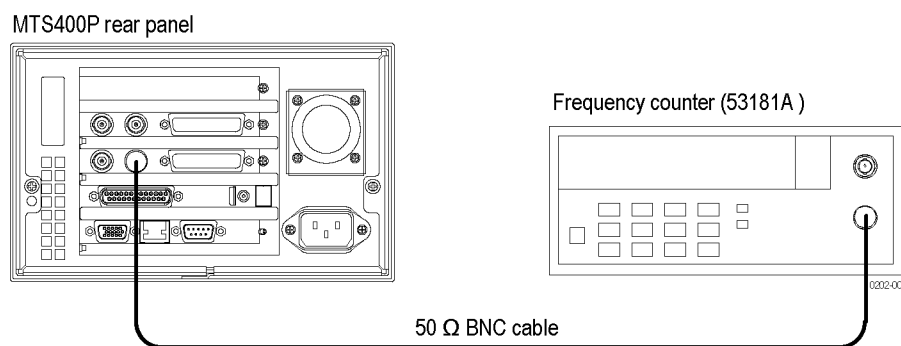
| Control          | Setting               |
|------------------|-----------------------|
| Vertical scale   | 1 V/div (CH1)         |
| Input impedance  | 50 Ω                  |
| Horizontal scale | 10 ns/div             |
| Trigger position | 50%                   |
| Acquire mode     | Average 16            |
| Trigger mode     | Auto                  |
| Trigger level    | 1.20 V                |
| Trigger source   | CH1                   |
| Trigger slope    | Rising Edge           |
| Input coupling   | DC                    |
| Measure          | High Level, Low level |

3. Select **Play > Others** on the MTS400P to open the Others dialog box.

4. In the dialog box, select the **Ext Trigger BNC** button to open the Ext Trigger BNC dialog box.
5. In the dialog box, set **BNC IN/OUT** to **Output** and **BNC OUT Selection** to **27 MHz**.
6. Verify that the measured values are as follows:

| Control    | Setting |
|------------|---------|
| High Level | > 2.2 V |
| Low Level  | < 0.8 V |

7. Disconnect the 50  $\Omega$  BNC cable from the oscilloscope CH1 input, and then connect the BNC cable to the CH1 connector on the frequency counter.



**Figure 2-7: Equipment connection for verifying the internal clock frequency**

8. Set the frequency counter settings as indicated below:

| Control   | Setting      |
|-----------|--------------|
| MEASURE   | Frequency1   |
| Gate Time | 0.20 s       |
| CHANNEL1  | Coupling: DC |
| Impedance | 50 $\Omega$  |
| Trigger   | AUTO TRIG ON |

9. Record the frequency counter reading in the test record. (See page 2-7.)
10. In the Ext Trigger BNC dialog box, change **BNC IN/OUT** to **Input**.
11. Disconnect the BNC cable from the MTS400P and the frequency counter.

### SPI Interface

This test verifies that the transport stream data is correctly played from and recorded through the SPI In/Out connector on the MTS400P.

#### Equipment required

- MPEG analyzer
- Parallel interface cable
- test40.TRP file

#### Checking the Play Operation.

1. Use the parallel interface cable to connect the SPI In/Out connector on the MTS400P to the DVB SPI In connector on the MPEG analyzer.

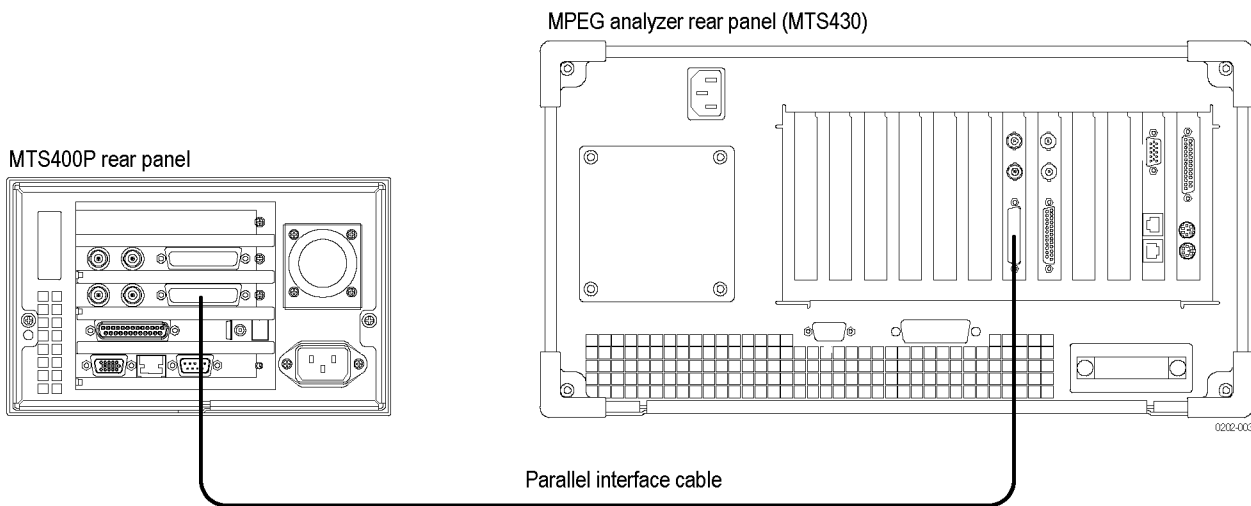


Figure 2-8: Equipment connection for verifying the SPI interface

2. Start the **MPEG Player** application on the MPEG analyzer.
3. Set the application to the **Record** mode.
4. Set the MPEG analyzer settings as follows:

| Control | Setting   |  |
|---------|-----------|--|
| Record  | Source    | SPI  |
|         | Target    | RAM  |
|         | Size      | 100 MB   |
| File    | Save Mode | Over Write   |
|         | Save      | E:\MTXRTX_Test streams\Record_Files\<br>SPI214Mbps |



5. To open the **test40.TRP** file on the MTS400P, do the following:
  - a. Select **File > Open** in the Play screen to open the Select File dialog box.
  - b. In the dialog box, select the **test40.TRP** file.
6. In the **Play** menu, make the following settings:

| Control | Setting             |
|---------|---------------------|
| Clock   | Data Rate: 214 Mbps |
| Update  | Off                 |
| Source  | RAM                 |

7. Press the **Play/Pause** button on the MTS400P to start playing the test40.TRP file.
8. Verify that the hierarchical view is displayed on the MPEG analyzer screen. In addition, verify that the bit rate is **214** Mbps and the packet size is **188** bytes.
9. Click the **Record** button on the MPEG Player application to record the file.
10. After the recording is complete, press the **Stop** button on the MTS400P.

#### Checking the Record Operation.

11. Change the interface cable connection from the DVB/SPI In connector to the DVB/SPI Out connector on the MPEG analyzer.
12. Press the **Record** button on the MTS400P to display the Record screen.
13. On the MTS400P, make the following settings:

| Control | Setting   |                            |
|---------|-----------|----------------------------|
| Record  | Source    | SPI                        |
|         | Target    | RAM                        |
|         | Size      | 100 MB                     |
|         | Save Mode | Over Write                 |
| File    | Save Mode | Over Write                 |
|         | Save      | D:\Record_Files\SPI214Mbps |

14. Change the MPEG analyzer to the Play mode.
15. Select **File > Open** on the MPEG analyzer to display the Open dialog box.
16. In the dialog box, navigate to the **E:\MTXRTX\_Test streams\ Record\_Files**, and then select the **SPI214Mbps.trp** file.

17. Set the MPEG analyzer settings as follows:

| Control   | Setting  |
|-----------|----------|
| Data Rate | 214 Mbps |
| Update    | Off      |
| Source    | RAM      |

18. Click the **Play/Pause** button on the MPEG Analyzer to start playing the **SPI214Mbps.trp** file.

19. Verify that the hierarchical view is displayed on the MTS400P screen. In addition, verify that the bit rate display is **214** Mbps and the packet size display is **188** bytes.

20. Press the **Record** button on the MTS400P to record the file.

21. After the recording is complete, click the **Stop** button on the MPEG analyzer.

22. Exit the MPEG Player application on the MPEG analyzer.

#### Checking the Recorded File.

23. Change the interface cable connection from the DVB/SPI Out connector to the DVB/SPI In connector on the MPEG analyzer.

24. Start the **TS Compliance Analyzer** on the MPEG analyzer.

25. In the TS Compliance Analyzer window, select **Real-time..** and make the following settings:

| Control            | Setting       |
|--------------------|---------------|
| Interfaces         | DVB Parallel  |
| Interface Settings | Time Stamping |

26. Click the **OK** button.

27. Press the **Play/Pause** button on the MTS400P to display the Play screen.

28. Select **File > Open** to open the Select File dialog box.

29. In the dialog box, navigate to the **D:\ Record\_Files** directory, and then select the **SPI214Mbps.trp** file.

30. Select **Play > Update > On**.

31. Press the **Play/Pause** button on the MTS400P to start playing the **SPI214Mbps.trp** file.

32. Verify that the hierarchical view is displayed on the MPEG analyzer screen and that no error messages appear. In addition, verify that the bit rate is **40** Mbps and that the transport stream packet size is **188** bytes.

---

**NOTE.** Ignore Program 3 and PID 120 (0x78) errors in the Navigation view because these are caused by the original test40.TRP file.

---

33. Press the **Stop** button on the MTS400P.

34. Close the TS Compliance Analyzer window.

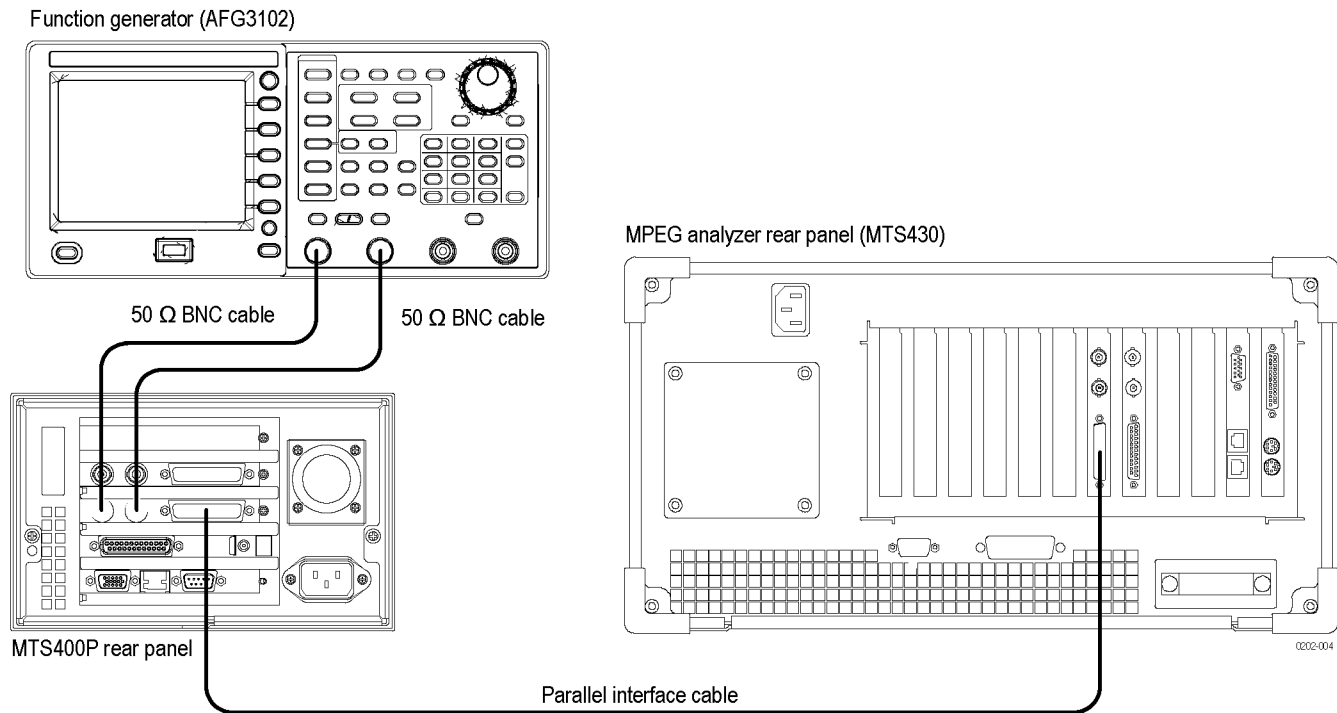
### **External Clock/Reference and External Trigger Inputs**

This test verifies that the external clock/reference input (Clock/Ref In) and external trigger input (Trig In/Out) on the MTS400P are functioning correctly.

#### **Equipment required.**

- MPEG analyzer
- Function generator
- Two 50  $\Omega$  BNC cables
- Parallel interface cable
- test64.TRP file

1. Use a 50  $\Omega$  BNC cable to connect the Clock/Ref In connector on the MTS400P to the Ch1 connector on the function generator.
2. Use the 50  $\Omega$  BNC cable to connect the Trig In/Out connector on the MTS400P to the Ch2 connector on the function generator.
3. Use the parallel interface cable to connect the SPI In/Out connector on the MTS400P to the DVB/SPI In connector on the MPEG analyzer.



**Figure 2-9: Equipment connections for verifying the external clock/reference and trigger inputs**

4. Set the function generator settings as indicated below:

| Control     | Setting          |  |
|-------------|------------------|--|
| Ch 1 output | Function         | Square   |
|             | Run Mode         | Continuous                                     |
|             | Frequency        | 10 MHz   |
|             | Output Amplitude | 0.5 V  |
|             | Output Offset    | 2.0 V  |
| Ch 2 output | Function         | Arb (Edit: Point Number: 100, All Data: 16382) |
|             | Run Mode         | Continuous                                     |
|             | Output Menu      | Load Impedance: 1 k $\Omega$                   |
|             | Output Amplitude | 1.75 V   |
|             | Output Offset    | 0.875 V  |

5. Press the **On** button of the Ch1 output on the function generator.
6. To open the **test64.TRP** file on the MTS400P, do the following:
  - a. Select **File > Open** in the Play screen to open the Select File dialog box.
  - b. In the dialog box, select the **test64.TRP** file.
7. Select **Play > Update > On**.
8. Select **Play > Clock** to open the Clock dialog box.
9. In the dialog box, select **ExtRef 10**.
10. Press the **Play/Pause** button on the MTS400P to start playing the **test64.TRP** file.
11. Verify that PLL unlock error does not occur on the MTS400P.
12. Start the **TS Compliance Analyzer** on the MPEG analyzer.
13. In the TS Compliance Analyzer window, select **Real-time..**, and then make the following settings:

| Control            | Setting       |
|--------------------|---------------|
| Interfaces         | DVB Parallel  |
| Interface Settings | Time Stamping |

14. Verify that the hierarchical view is displayed on the MPEG analyzer screen and that no error messages appear. In addition, verify that the data rate is **64** Mbps and that the packet size is **188** bytes.

**NOTE.** Ignore Program 3 and PID 120 (0x78) errors in the Navigation view because these are caused by the original test40.TRP file.

15. Change the clock source setting on the MTS400P and output frequency setting on the function generator with the following and then repeat step 14.

| Clock source setting (MTS400P) | Output frequency setting (function generator) |
|--------------------------------|---|
| ExtRef 27                      | 27 MHz  |
| Ext Ref 8.126984 MHz           | 8.126984 MHz                                  |
| Ext P Clk                      | 8 MHz   |

16. Change the output frequency of the function generator to 32 MHz.

---

**NOTE.** You have to click the Ext S Clk to select the Ext P Clk.

---

17. Select **Play > Clock** on the MTS400P to open the Clock dialog box.

18. In the dialog box, select **Ext S Clk**.

19. Repeat step 14 and verify that all items in the **Priority 1** row are green.

---

**NOTE.** Ignore 2.3.a PCR Repetition and 2.5 PTS errors in the Priority 2 row.

---

20. Press the **Stop** button on the MTS400P to stop the stream output.

21. Select **Play > Clock** on the MTS400P to open the Clock dialog box.

22. In the Clock dialog box, select **Internal**.

23. Press the **On** button of the Ch1 output on the function generator to stop the signal output.

24. Press the **On** button of the Ch2 output on the function generator to start the signal output.

25. Select **Play > Others** on the MTS400P to open the Others dialog box.

26. In the Others dialog box, set **Ext Play Start** to **Rise**.

27. Verify that the MTS400P starts playing when the Output menu is set to **Invert** on the function generator.

28. Press the **Stop** button on the MTS400P to stop the stream output.

29. Press the **On** button of the Ch2 output on the function generator to stop the signal output.

30. Return **Ext Play Start** to **Off** on the MTS400P.

31. Disconnect all cables from the MTS400P, the function generator, and the MPEG analyzer.

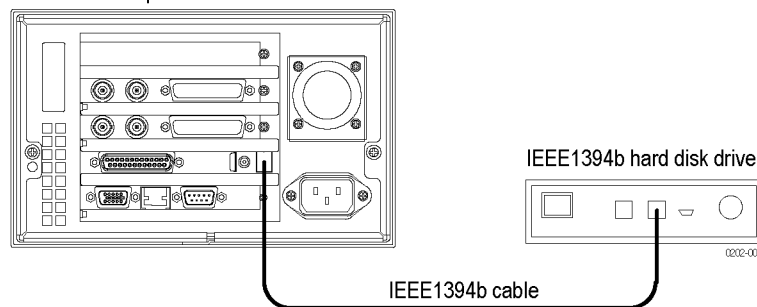
**IEEE1394b Interface** This test verifies that the IEEE1394b interface is functioning correctly.

**Equipment required.**

- IEEE1394b hard disk drive
- IEEE1394b cable (9 pin-9 pin)
- test40.TRP file

1. Use the IEEE1394b cable to connect the IEEE1394b connector on the MTS400P to the IEEE1394b hard disk drive.

MTS400P rear panel



**Figure 2-10: Equipment connection for verifying the IEEE1394b interface**

2. Select **Play** > **Minimize** to minimize the MTS400P application.
3. Power on the IEEE1394b hard disk drive.
4. Double-click the **My Computer** icon on the Windows desktop to open the My Computer window.
5. In the window, verify that the hard disk drive is recognized as the **F:** (or **G:**) drive.
6. Use the Windows file copy operation to copy the **test40.TRP** file on the **D:** drive to **F:** (or **G:**) drive.
7. Verify that the **test40.TRP** file is copied to the F: (or G:) drive correctly.
8. Delete the **test40.TRP** file from the F: (or G:) drive.
9. Power off the IEEE1394b hard disk drive.

**SMPTE310M/ASI/SPI Interface**

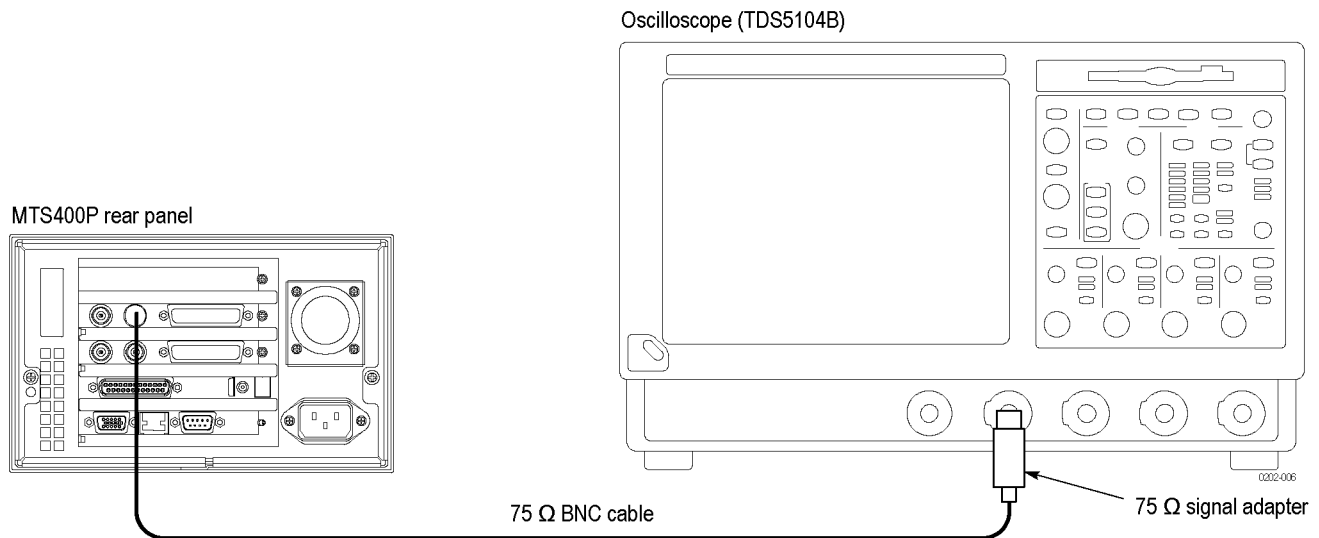
This test verifies that the transport stream data is correctly output from and is recorded through the SMPTE310M/ASI/SPI interface on the MTS400P.

**Equipment required.**

- Oscilloscope
- MPEG analyzer
- 75 Ω precision termination
- 75 Ω BNC cable
- 75 Ω signal adapter
- test40.TRP file
- Flower.trp file

**Checking the Output Signal.**

1. Use the 75 Ω BNC cable and the 75 Ω signal adapter to connect the SMPTE310M/ASI Output connector on the MTS400P to the oscilloscope CH1 input.



**Figure 2-11: Equipment connection for verifying output signal-SMPTE310M interface**

2. Set the oscilloscope settings as indicated below:

| Control          | Setting     |
|------------------|-------------|
| Vertical scale   | 200 mV/div  |
| Horizontal scale | 1.25 ns/div |
| Trigger position | 50%         |
| Acquire mode     | Average 32  |



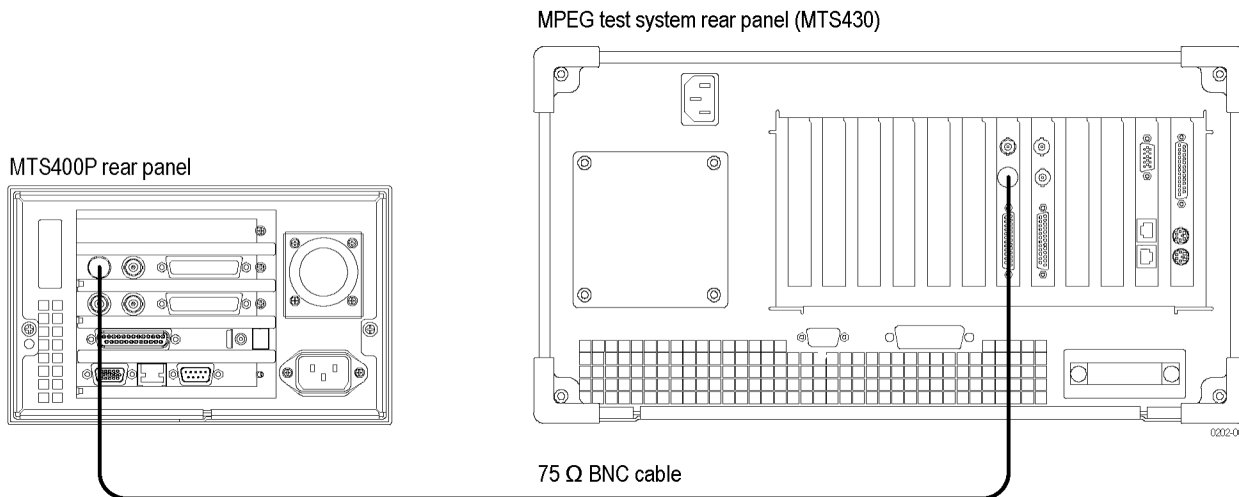
| Control         | Setting                            |
|-----------------|------------------------------------|
| Trigger mode    | AUTO                               |
| Trigger source  | CH1                                |
| Trigger level   | 0 V                                |
| Trigger slope   | Rising Edge                        |
| Input impedance | 50 $\Omega$                        |
| Measure         | Amplitude, Rise Time, Fall Time    |
| Ref Level       | High Ref 80%, Low Ref 20%          |
| Gating Cursor   | Curs1 Pos1: -2.5 ns/Curs2: 2.75 ns |

3. To open the **test40.TRP** file on the MTS400P, do the following:
  - a. Select **File > Open** to open the Select File dialog box.
  - b. In the dialog box, select the **test40.TRP** file.
4. Press the **Play/Pause** button on the MTS400P to start playing the **test40.TRP** file.
5. Use the oscilloscope to measure that the amplitude, rise and fall times are as follows:

| Control            | Setting          |
|--------------------|------------------|
| Amplitude          | 720 mV to 880 mV |
| Rise and fall time | $\leq 1.2$ ns    |

**Checking the ASI Play Operation.**

1. Disconnect the BNC cable from the 75 Ω signal adapter on the oscilloscope input, and connect the cable to the ASI/SMPTE In connector on the MPEG analyzer.



**Figure 2-12: Equipment connection for verifying the ASI play operation**

2. Start the **MPEG Player** application on the MPEG analyzer.
3. Set the application to the **Record** mode.
4. Set the MPEG analyzer settings as follows:

| Control      | Setting     |  |
|--------------|-------------|--|
| Record       | Source      | SPI/ASI/310M                                       |
|              | Target      | RAM  |
|              | Record Size | 100 MB   |
| SPI/ASI/310M | Input Port  | BNC  |
|              | BNC Port    | ASI  |
| File         | Save Mode   | Over Write   |
|              | Save        | E:\MTXRTX_Test streams\Record_Files\ASI214Mbps.trp |

5. On the MTS400P, make the following settings:

| Control      | Setting         |          |
|--------------|-----------------|----------|
| Play         | Clock Data Rate | 214 Mbps |
|              | Update          | Off      |
|              | Source          | RAM      |
| 310M/ASI/SPI | BNC Port        | ASI      |
|              | Through Out     | Off      |

6. Press the **Play/Pause** button on the MTS400P to start playing the **test40.TRP** file.
7. Verify that the hierarchical view is displayed on the MPEG analyzer screen. In addition, verify that the bit rate is **214** Mbps and the packet size is **188** bytes.
8. Click the **Record** button on the MPEG Player application to record the file.
9. After the recording is complete, press the **Stop** button on the MTS400P.
10. Disconnect the 75  $\Omega$  BNC cable from the MTS400P and the MPEG analyzer.

#### Checking the ASI Record Operation.

1. Use the 75  $\Omega$  BNC cable to connect the SMPTE/ASI Input connector on the MTS400P to the ASI/SMPTE Out connector on the MPEG analyzer.

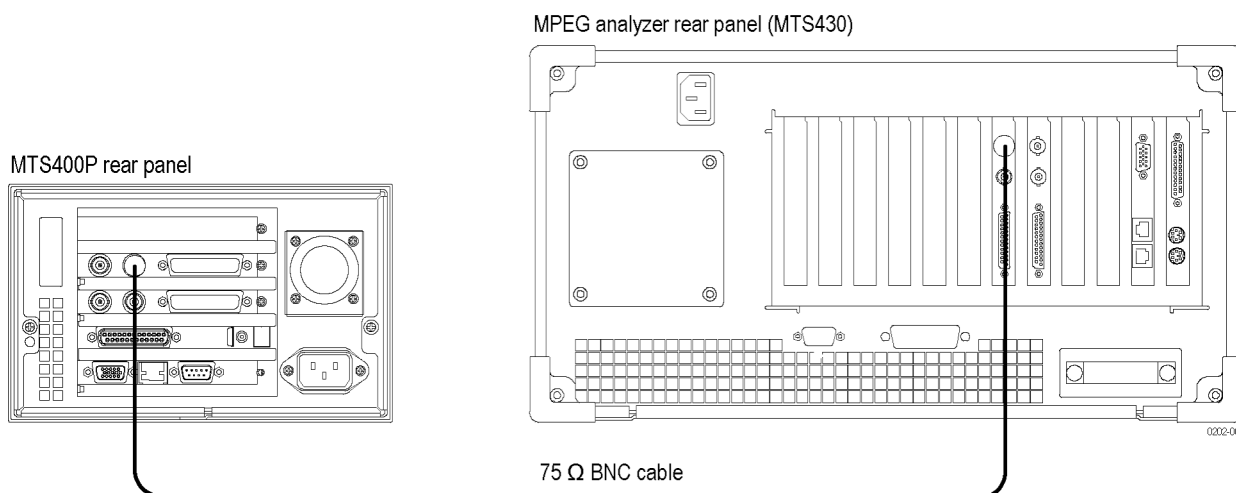


Figure 2-13: Equipment connection for verifying the ASI record operation

2. Press the **Record** button on the MTS400P to display the Record screen.
3. On the MTS400P, make the following settings:

| Control      | Setting     |                                |
|--------------|-------------|--------------------------------|
| Record       | Source      | 310M/ASI/SPI                   |
|              | Record size | 100 MB                         |
|              | Target      | RAM                            |
| 310M/ASI/SPI | Input Port  | BNC                            |
|              | BNC Port    | ASI                            |
| File         | Save Mode   | Over Write                     |
|              | Save        | D:\Record_Files\ASI214Mbps.trp |

4. Set the MPEG analyzer to the Play mode.

5. Select **File > Open** on the MPEG analyzer to display the Open dialog box.
6. In the dialog box, navigate to the **E:\MTXRTX\_Test Streams\Record\_Files** directory, and select the **ASI214Mbps.trp** file.
7. Set the following settings on the MPEG analyzer:

| <b>Control</b> |                 | <b>Setting</b> |
|----------------|-----------------|----------------|
| Play           | Clock Data Rate | 214 Mbps       |
|                | Update          | Off            |
|                | Source          | RAM            |
| SPI/ASI/310M   | BNC Port        | ASI            |
|                | Through Out     | Off            |

8. Click the **Play** button on the MPEG analyzer to start playing the **ASI214Mbps.trp** file.
9. Verify that the hierarchical view is displayed on the MTS400P screen. In addition, verify that the bit rate is **214** Mbps and packet size is **188** bytes.
10. Press the **Record** button on the MTS400P to record the file.
11. After the recording is complete, click the **Stop** button on the MPEG analyzer.
12. Exit the MPEG Player application on the MPEG analyzer.
13. Disconnect the BNC cable from the MTS400P and the MPEG analyzer.

### Checking the Recorded File.

1. Use the 75  $\Omega$  BNC cable to connect the SMPTE310M/ASI Output connector on the MTS400P to the ASI/SMPTE In connector on the MPEG analyzer.

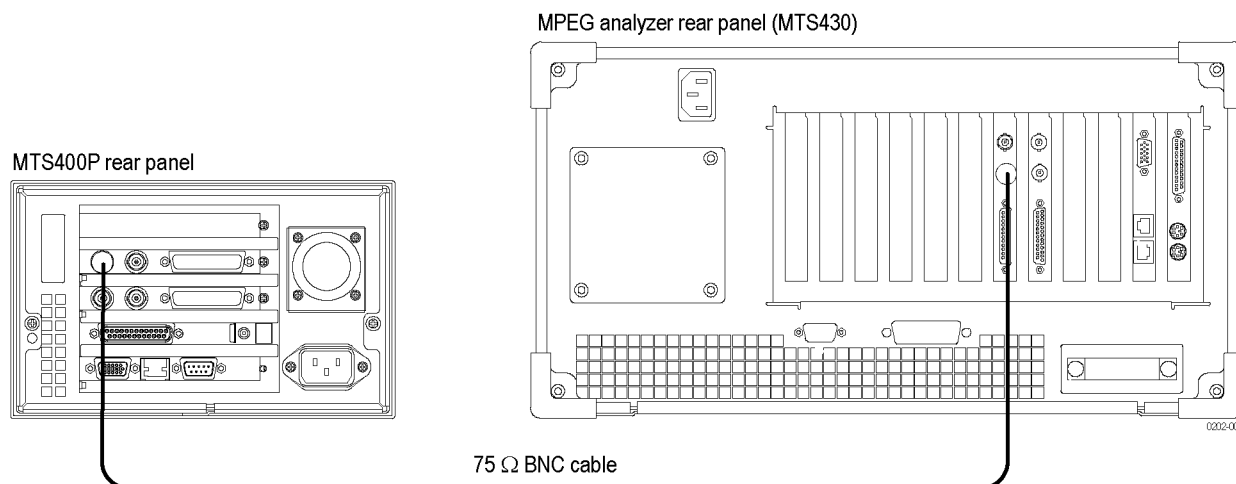


Figure 2-14: Equipment connection for verifying the recorded file-ASI interface

2. Press the **Play/Pause** button on the MTS400P to display the Play screen.
3. Select **Play > Update > On**.
4. To open the **ASI214Mbps** file on the MTS400P, do the following:
  - a. Select **File > Open** to open the **Select File** dialog box.
  - b. In the dialog box, navigate to the **D:\Record\_Files** directory, and then select the **ASI214Mbps.trp** file.
5. Press the **Play/Pause** button to start playing the file.
6. Start the **TS Compliance Analyzer** on the MPEG analyzer.
7. In the TS Compliance Analyzer window, select **Real-time..**, and make the following settings:

| Control            | Setting       |
|--------------------|---------------|
| Interfaces         | ASI           |
| Interface Settings | Time Stamping |

8. Verify that the hierarchical view is displayed on the MPEG analyzer screen and that no error messages appear. In addition, verify that the bit rate is **40** Mbps and that the packet size is **188** bytes.

---

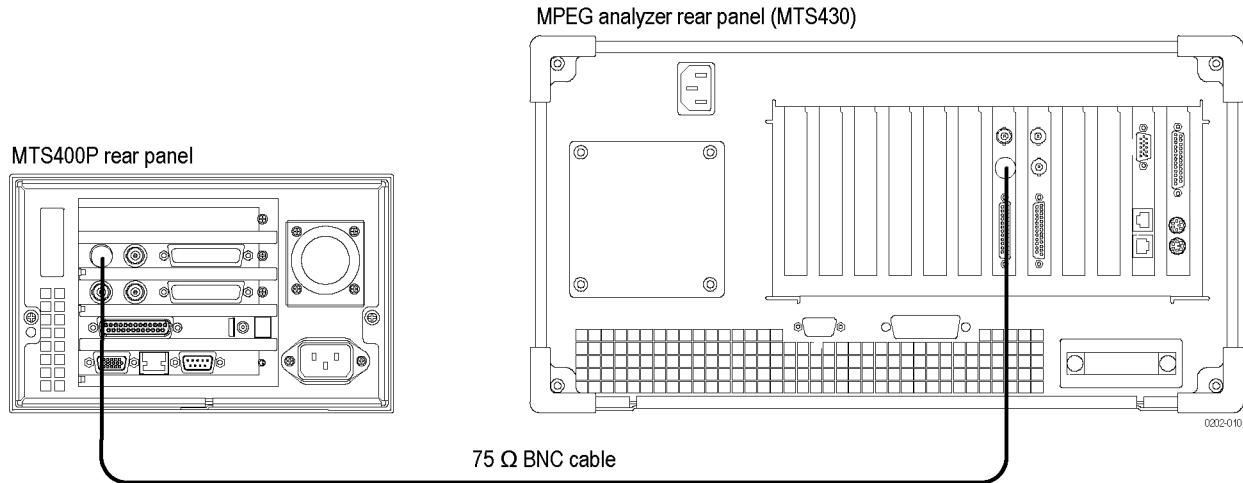
**NOTE.** Ignore Program 3 and PID 120 (0x78) errors in the hierarchical view because these are caused by the original test40.TRP file.

---

9. Press the **Stop** button on the MTS400P to stop the stream output.
10. Disconnect the 75  $\Omega$  BNC cable from the MTS400P and the MPEG analyzer.

**Checking the SMPTE310M Play Operation.**

1. Use the 75  $\Omega$  BNC cable to connect the SMPTE310M/ASI Output connector on the MTS400P to the ASI/SMPTE In connector on the MPEG analyzer.



**Figure 2-15: Equipment connection for verifying the SMPTE310M play operation**

2. Start the **MPEG Player** application on the MPEG analyzer.
3. Set the application to the **Record** mode.

4. Set the MPEG analyzer settings as indicated below:

| Control      |             | Setting   |
|--------------|-------------|---|
| Record       | Source      | SPI/ASI/310M                                      |
|              | Target      | RAM   |
|              | Record Size | 100 MB  |
| SPI/ASI/310M | Input Port  | BNC   |
|              | BNC Port    | 310M  |
| File         | Save Mode   | OverWrite   |
|              | Save        | E:\MTXRTX_Test streams\Record_Files\<br>S310M.trp |

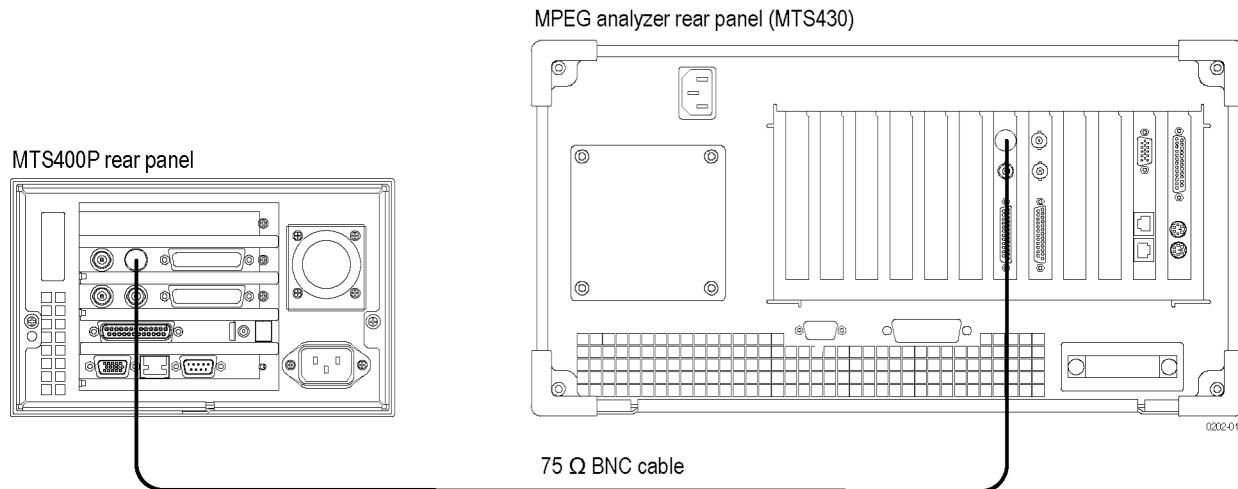
5. To open the **Flower.trp** file on the MTS400P.
- Select **File > Open** to open the Select File dialog box.
  - In the dialog box, navigate to the **D:\525** directory, and select the **Flower.trp** file.
6. On the MTS400P, make the following settings:

| Control      |                 | Setting        |
|--------------|-----------------|----------------|
| Play         | Clock Data Rate | 19.392658 Mbps |
|              | Update          | Off            |
|              | Source          | RAM            |
| 310M/ASI/SPI | BNC Port        | 310M 8VSB      |
|              | Through Out     | Off            |

- Press the **Play/Pause** button on the MTS400P to start playing the **Flower.trp** file.
- Verify that the hierarchical view is displayed on the MPEG analyzer screen. In addition, verify that the bit rate is **19.392** Mbps and packet size is **188** bytes.
- Click the **Record** button on the MPEG Player application to record the file.
- After the recording is completed, press the **Stop** button on the MTS400P.
- Disconnect the 75  $\Omega$  BNC cable from the MTS400P and the MPEG analyzer.

**Checking the SMPTE310M Record Operation.**

1. Use the 75 Ω BNC cable to connect the SMPTE310M/ASI Input connector on the MTS400P to the ASI/SMPTE Out connector on the MPEG analyzer.



**Figure 2-16: Equipment connection for verifying the SMPTE310M record operation**

2. Press the **Record** button on the MTS400P to display the Record screen.
3. On the MTS400P, make the following settings:

| Control      |             | Setting                   |
|--------------|-------------|---------------------------|
| Record       | Source      | 310M/ASI/SPI              |
|              | Record size | 100 MB                    |
|              | Target      | RAM                       |
| 310M/ASI/SPI | Input Port  | BNC                       |
|              | BNC Port    | 310M                      |
| File         | Save Mode   | Over Write                |
|              | Save        | D:\Record_Files\S310M.trp |

4. Set the MPEG analyzer to the Play mode.
5. Select **File > Open** on the MPEG analyzer to display the Open dialog box.
6. In the dialog box, navigate to the **E:\MTXRTX\_Test Streams\Record\_Files** directory, and select the **S310M.trp** file.



7. On the MPEG player, make the following settings:

| Control      |             | Setting   |
|--------------|-------------|-----------|
| Play         | Update      | Off       |
|              | Source      | RAM       |
| SPI/ASI/310M | BNC Port    | 310M 8VSB |
|              | Through Out | Off       |

8. Click the **Play** button on the MPEG analyzer to start playing the **S310M.trp** file.
9. Verify that the hierarchical view is displayed on the MTS400P screen. In addition, verify that the bit rate is **19.392** Mbps and packet size is **188** bytes.
10. Press the **Record** button on the MTS400P to record the file.
11. After the recording is complete, click the **Stop** button on the MPEG analyzer.
12. Exit the MPEG Player application on the MPEG analyzer.
13. Disconnect the 75  $\Omega$  BNC cable from the MTS400P and the MPEG analyzer.

#### Checking the Recorded File.

1. Use the 75  $\Omega$  BNC cable to connect the SMPTE310M/ASI Output connector on the MTS400P to the ASI/SMPTE In connector on the MPEG analyzer.

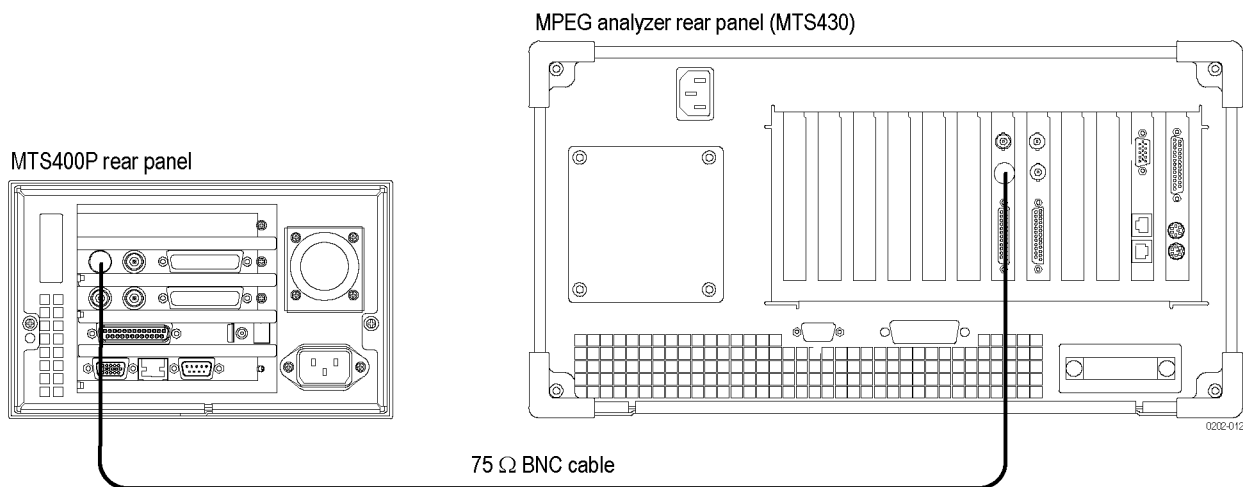


Figure 2-17: Equipment connection for verifying the recorded file-ASI interface

2. Press the **Play/Pause** button on the MTS400P to display the Play screen.
3. To open the **310M.trp** file on the MTS400P, do the following:
  - a. Select **File > Open** to open the Select File dialog box.
  - b. In the dialog box, navigate to the **D:\Record\_Files** directory, and select the **310M.trp** file.

4. Select **Play > Update > On**.
5. Press the **Play/Pause** button to start playing the file.
6. Start the **TS Compliance Analyzer** on the MPEG analyzer.
7. In the TS Compliance Analyzer window, select **Real-time..**, and make the following settings:  
Interfaces: ASI  
Interface Settings: Time Stamping
8. Verify that the hierarchical view is displayed on the MPEG analyzer screen and that no error messages appear. In addition, verify that the bit rate is **19.392** Mbps and that the packet size is **188** bytes.

---

**NOTE.** Ignore 3.4.a Unref PID error in the Priority 3 row.

---

9. Press the **Stop** button on the MTS400P to stop the stream output.
10. Disconnect the 75  $\Omega$  BNC cable from the MTS400P and MPEG analyzer.

### Checking the SPI Record Operation.

1. Use the parallel interface cable to connect the SPI Input connector on the MTS400P to the DVB SPI Out connector on the MPEG analyzer.

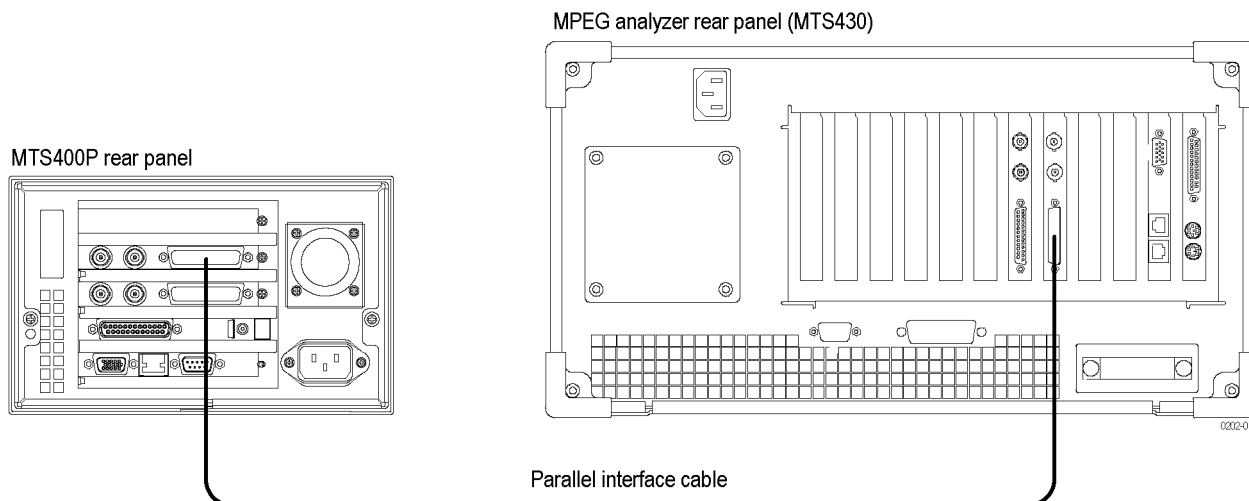


Figure 2-18: Equipment connection for verifying the SPI record operation

2. Press the **Record** button on the MTS400P to display the Record screen.
3. On the MTS400P, make the following settings:

| Control | Setting     |                            |
|---------|-------------|----------------------------|
| Record  | Source      | SPI                        |
|         | Target      | RAM                        |
|         | Record Size | 100 MB                     |
| File    | Save Mode   | Over Write                 |
|         | Save Mode   | D:\Record_Files\SPI214Mbps |

4. Change the MPEG analyzer to Play mode.
5. Select **File > Open** on the MPEG analyzer to display the Open dialog box.
6. In the dialog box, navigate to the **E:\MTXRTX\_Test streams\Record\_Files**, and select the **SPI214Mbps.trp** file.

7. On the MPEG analyzer, make the following settings:

| <b>Control</b> |                 | <b>Setting</b> |
|----------------|-----------------|----------------|
| Play           | Clock Data Rate | 214 Mbps       |
|                | Update          | Off            |
|                | Source          | RAM            |

8. Click the **PLAY** button on the MPEG Analyzer to start playing the **SPI214Mbps.trp** file.
9. Verify that the hierarchical view is displayed on the MTS400P screen. In addition, verify that the bit rate display is **214** Mbps and the packet size display is **188** bytes.
10. Press the **Record** button on the MTS400P to record the file.
11. After recording is complete, click the **Stop** button on the MPEG analyzer.
12. Exit the MPEG Player application on the MPEG analyzer.

#### **Checking the Recorded File.**

1. Change the interface cable connection from DVB/SPI Out connector to DVB/SPI In connector on the MPEG analyzer.
2. Start the **TS Compliance Analyzer** on the MPEG analyzer.
3. In the TS Compliance Analyzer window, select **Real-time..**, and make the following settings:
  - Interfaces ASI
  - Interface Settings Time Stamping
4. Press the **Play/Pause** button on the MTS400P to display the Play screen.
5. Select **File > Open** to open the Select File dialog box.

6. In the dialog box, navigate to the **D:\ Record\_Files** directory, and select the **SPI214Mbps.trp** file.
7. Select **Play > Update > On**.
8. Press the **Play/Pause** button on the MTS400P to start playing the **SPI214Mbps.trp** file.
9. Verify that the hierarchical view is displayed on the MPEG analyzer screen and that no error messages appear. In addition, verify that the bit rate is **40** Mbps and that the transport stream packet size is **188** bytes.

---

**NOTE.** *Ignore Program 3 and PID 120 (0x78) errors in the hierarchical view because these are caused by the original test40.TRP file.*

---

10. Press the **Stop** button on the MTS400P.
11. Close the TS Compliance Analyzer window.

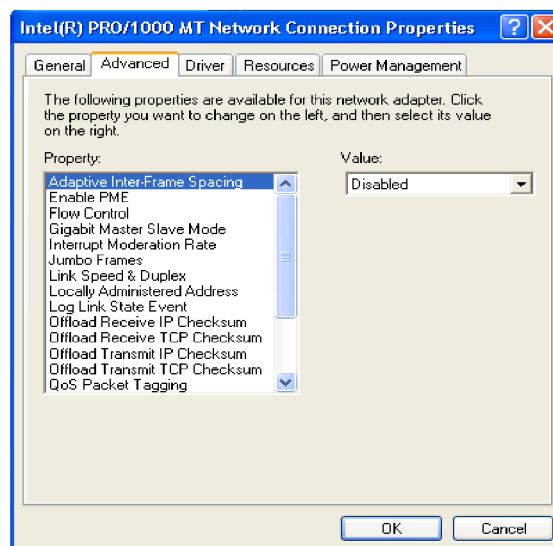
**IP Interface** The following tests verify that the transport stream data is correctly output from the MTS400P instrument.

**Recommended Settings for MPEG Player in IP mode.**

Perform this procedure in Category/Classic view to check the settings of Intel/Pro 1000 MT drivers:

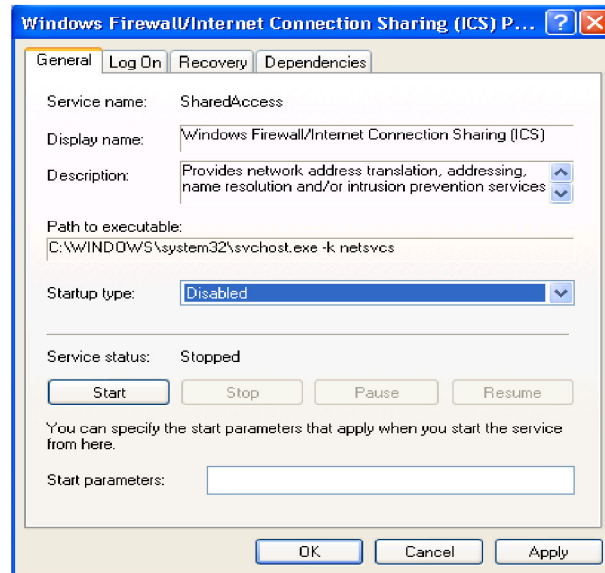
1. Click **Control Panel > Network and Internet Connections > Network Connections** in Category view or click **Control Panel > Network Connections** in Classic view.
2. Select **Intel(R) Pro/1000 MT Network Connection** device and right-click to select the **Properties** option.
3. Click **Configure > Advanced** and check if the following options are set in the dialog box:

| Control                      | Setting   |
|------------------------------|---|
| Adaptive Inter-Frame Spacing | Disabled  |
| Flow Control                 | Off   |
| Interrupt Moderation Rate    | Off   |
| Jumbo Frames                 | 16128   |
| Link Speed and Duplex        | Auto-negotiate 1000Mbps   |
|                              | <i><b>NOTE.</b> If the MTS400P MPEG system is connected to 100 Mbps network, select "Auto Detect" for Link Speed and Duplex option.</i> |
| Receive Descriptors          | 2048  |

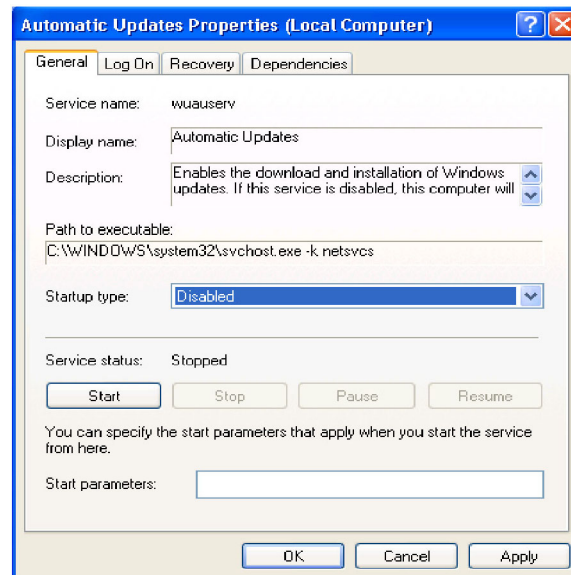


Perform this procedure to check the settings of Administrative tools for improved performance during the Playout:

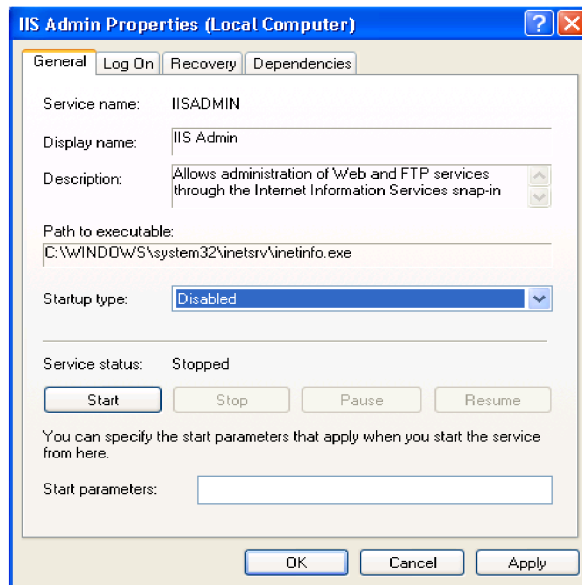
1. Click **Control Panel > Administrative Tools > Services** in Classic view.
2. Select **Windows Firewall/Internet Connection Sharing (ICS)** to open the dialog box. Check if the Startup type is set to **Disabled**.



3. Select **Automatic Updates** to open the dialog box. Check if the Startup type is set to **Disabled**.

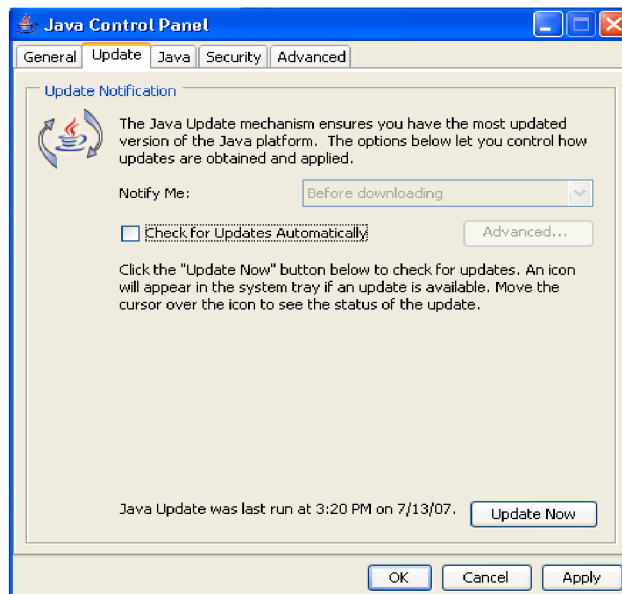


4. Select IIS admin to open the dialog box. Check if the Startup type is set to **Disabled**.



Perform this procedure to check if the automatic Java updates are disabled:

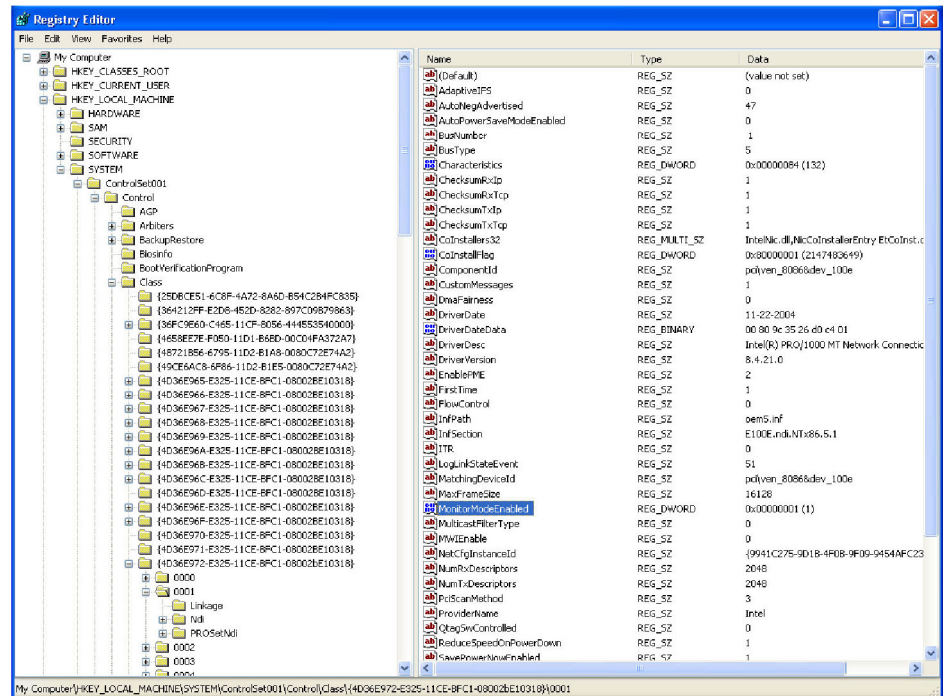
1. Click **Control Panel > Java**.
2. Select the **Update** tab and check if the **Check for Updates Automatically** check box is deselected.



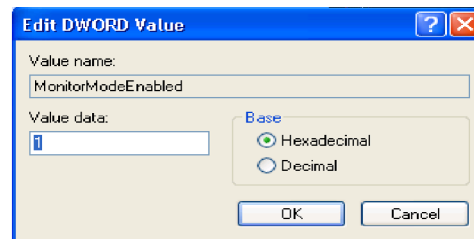


Perform this procedure to check for the settings of VLAN:

1. Click **Start > Run** and type **regedit**. Press **OK** to display the Registry Editor Window.
2. Browse to **HKEY\_LOCAL\_MACHINE\SYSTEM\ControlSet001\Control\Class\{4D36E972-E325-11CE-BFC1-08002BE10318}\00XX** where **XX** is the instance of the network adapter that you need to see tags on. You can check by opening and viewing the driver descriptor value (**DriverDesc** value should be **Intel(R) PRO/1000 MT Network Connection**).



3. Select **MonitorModeEnabled** **DWORD** Value that you created.
4. Double-click the **DWORD** Value to open the **Edit DWORD Value** dialog box. Check if the **Value data** is set to **1**.



**Checking Option GbE performance.** Perform this procedure to check that the GbE Gigabit Ethernet interface of MTS400P is operating properly. This test checks that the transport stream data is correctly output from the MTS400P instrument.

**Equipment required.**

- MTS400 Series MPEG system
  - RJ-45 cables
  - Crossover RJ-45 cable
1. Connect the equipment as shown below.

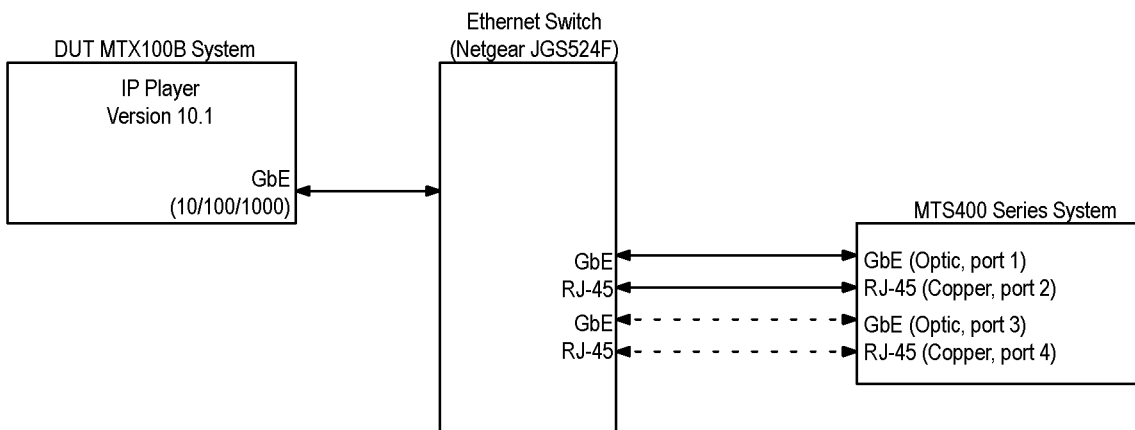


Figure 2-19: Equipment setup for Option GbE performance verification

---

**NOTE.** Check that V10.1 or greater MTS400P software is installed.

---

2. Power on the MTS400 Series MPEG system and allow the Windows operating system to boot completely. Wait an additional 90 seconds for the MPEG system to complete the Option GbE firmware loading process.
3. Configure the DUT MTS400P system with the following settings for GbE testing:

- a. Double-click the **MTS400P MPEG Test System** icon on the desktop to start the player.



- b. From the **File** menu, select **Open > Look in (dropdown menu) > Local Disk (D) > test streams > test40.TRP > Open**.

- c. Make the following selections in the Play menu:

Play Interface > IP

Play Packet Size >188

Play Clock dialog box

Make sure the Internal button is selected

Make sure the "Data Rate" section shows:

$$\frac{40}{27} \times 27.0 = 40.000000$$

Play > Update > On (checked)

Play > PCR Initial Value... dialog box:

Base Value (33): 0

Extension Value (9): 0

Click the OK button

Play > Source > Disk (checked)

Play > Loop > On (checked)

Start > Stop... dialog box:

Start radio button selected

0% text-entry-box set to 0

100% text-entry-box set to 386555

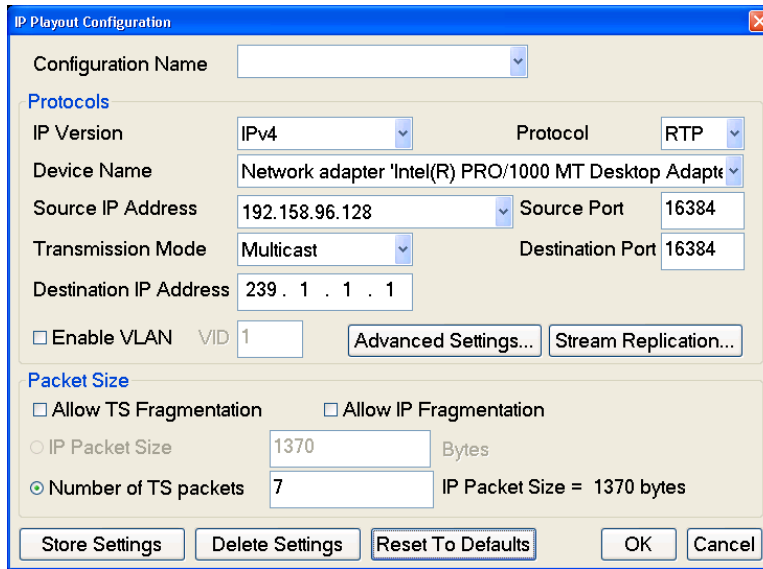
Format set to Packets

Play > Auto Play > Off (checked)

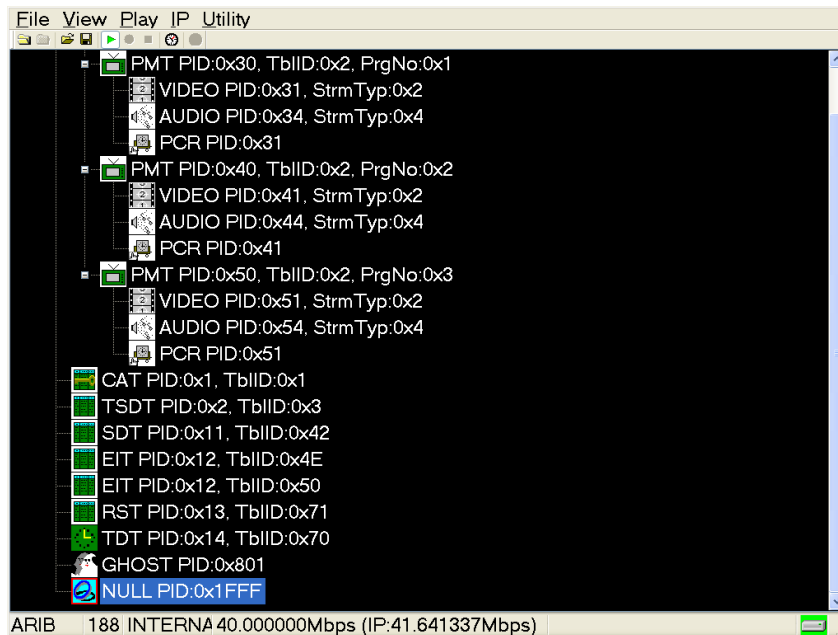
Play > Timer Play... (ignore this; it should show the current date and time)


4. Select Configuration from the IP menu to launch the IP Payout Configuration dialog box, and make the following entries/selections.

| Control                | Setting                                 |
|------------------------|---|
| Device Name            | Intel(R) PRO/1000 MT Network Connection |
| Transmission Mode      | Multicast                               |
| Destination IP Address | 239.1.1.1                               |
| Protocol               | UDP                                     |
| Destination Port       | 1234                                    |



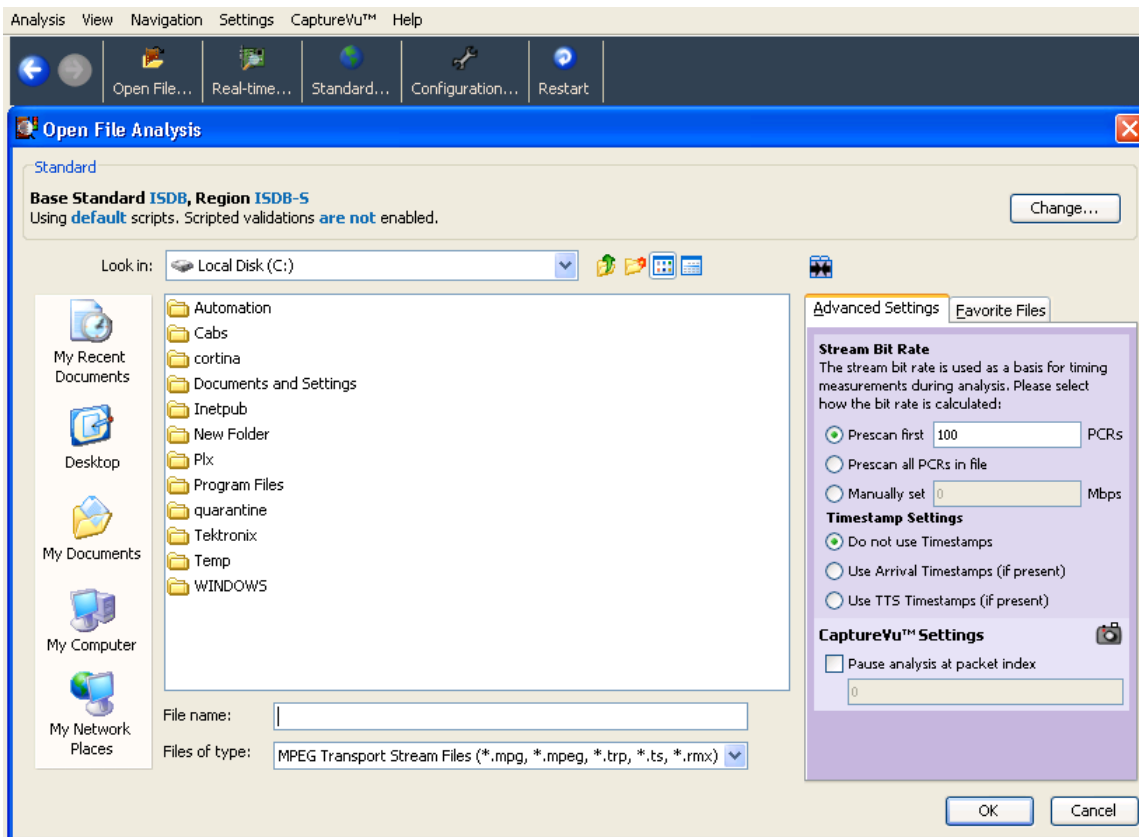
Now the MTS400P MPEG Test System should appear as the following figure.



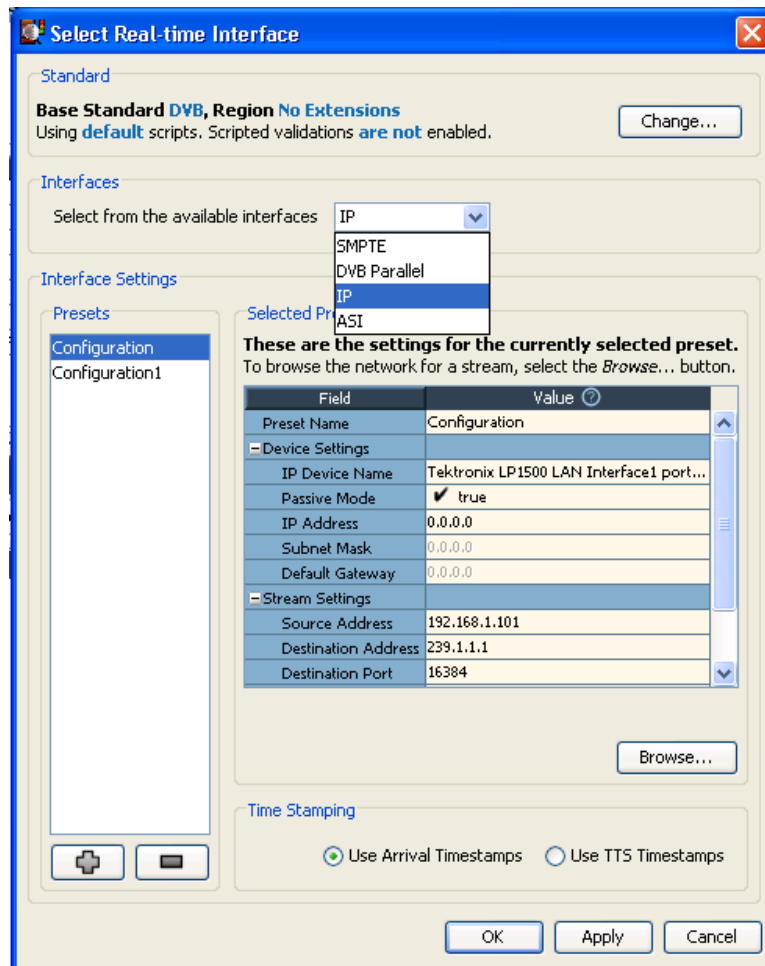
5. Click the **Start** button (  ) to start the stream playback.
6. Double-click the MTS400 Series system's **TS Compliance Analyser**



desktop icon `TS Compliance Analyser.lnk` to launch the TS Compliance Analyser application (TSCA). This starts with the Open Transport Stream dialog box as shown in the following figure.



7. Select **Real-time...**. The Select Real-time Interface dialog box appears.
8. In the Select Real-time Interface dialog box, select **IP** from the Interfaces drop-down menu.



9. Click the **Browse** button to open the Browse for UDP Flow dialog box. (See Figure 2-20.)

---

**NOTE.** You may have to click the + button below the Configurations list to make the settings pane change. The Browse button, which is needed for the next step, will then be active.

---

10. Select Tektronix LP1500 LAN Interface Port 4 from the **Browse Device** drop-down menu.
11. In the Browse for UDP flow dialog box, make these selections:
  - a. Select the Passive mode radio button.
  - b. In the Detected UDP Flows pane, select the IP stream with a Destination IP Address of 239.1.1.1.

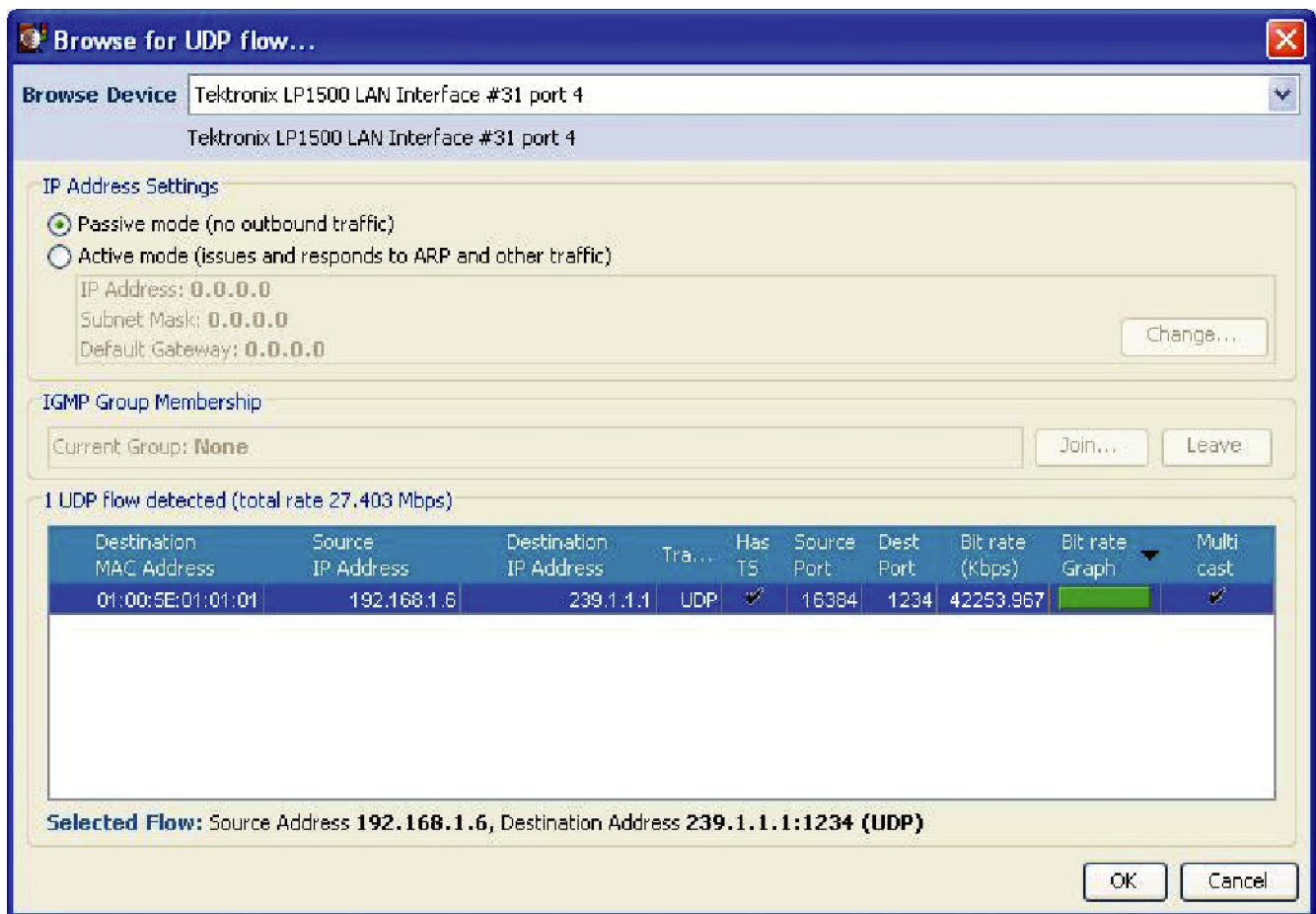


Figure 2-20: IP Flow selection

- c. Click the **OK** button. The MTS400 Series TS Compliance Analyzer dialog box opens.
12. Allow the DUT MTS400P MPEG system to loop at least three times.
  13. On the MTS400 Series MPEG system, verify that the TS Availability and Sync indicators, in the bottom left corner of the Compliance Analyzer display, remain green.
  14. Check that all the parameters under **Priority 1** of the Compliance Analyzer display are green. The TS bit rate displayed in the status bar should be approximately equal to 40.00000 Mbps which was set in the MTS400P instrument.

---

**NOTE.** Ignore the 2.5 PTS errors as they are generated by the test40.trp file.

---

The screenshot displays the IP - MPEG TS Compliance Analyzer software. The main window shows the following data:

**Transport Stream: Id 1, Network Name: Dennis' Network**

- Number of Programs: 3
- Current TS bit rate: 40.000 Mbps
- Current TS bit rate excluding Null PID: 20.977 Mbps

| Name                  | Number  | Current Bit Rate | Current(Mb/s) | Min(Mbps) | Max(Mbps) | %      |
|-----------------------|---------|------------------|---------------|-----------|-----------|--------|
| 625 PAL Matrix        | 1 (0x1) | [Progress Bar]   | 6.927         | 0.000     | 6.929     | 17.48% |
| BBC Clip              | 2 (0x2) | [Progress Bar]   | 6.927         | 0.000     | 6.929     | 17.48% |
| Flower Garden         | 3 (0x3) | [Progress Bar]   | 6.927         | 6.923     | 6.929     | 17.48% |
| NULL PID 8191 (0x...) |         | [Progress Bar]   | 19.018        | 14.323    | 19.035    | 47.55% |

The bottom status bar indicates: TS Availability (green), Sync (green), 39.999951 Mbps @ 188, 188, DVB, No Extensions, Interface: IP (RTP/UDP).

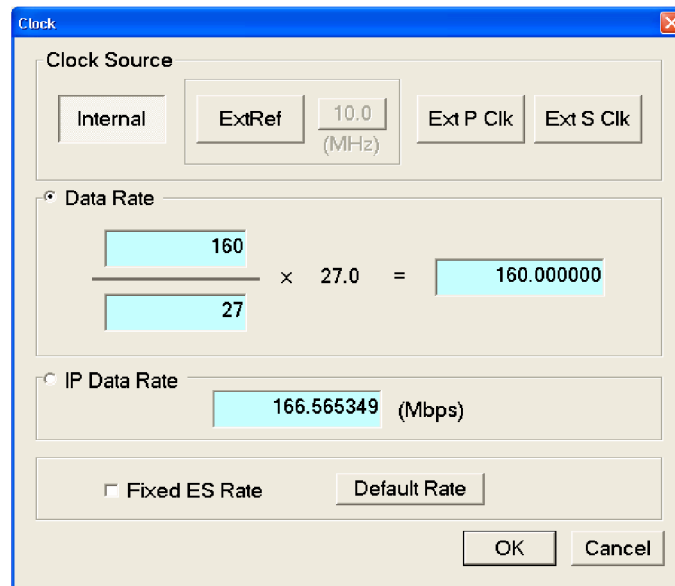
15. Disconnect the DUT MTS400P MPEG system from the test setup and turn it off using the front panel POWER switch. After the Windows shutdown completes, unplug the power cord from the system.
16. Disconnect the MTS400 Series MPEG system from the test setup:
  - a. Disconnect the cable to the SFP module.
  - b. Remove the SFP module.
  - c. Close all applications running on the MTS400 Series MPEG system and turn it off using the front panel POWER switch. After the Windows shutdown completes, unplug the power cord from the system.



**Checking maximum bit rate performance.** Perform this test to check that the maximum transport stream data is correctly output from the MTS400P instrument.

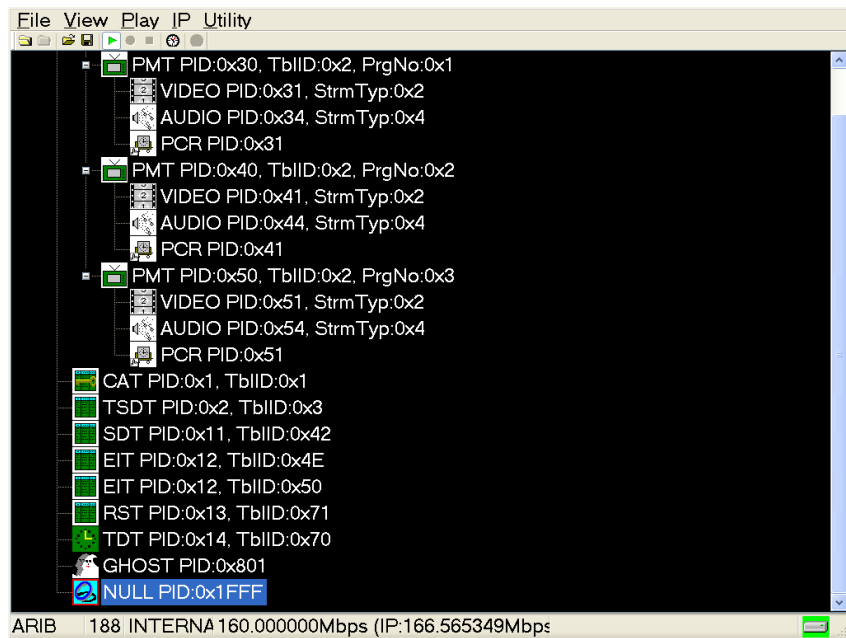
**NOTE.** You can perform the maximum bit rate performance test on MTS400 Series with a Cheetah card only.

1. Perform the steps 1 through 4 listed in the *Checking Option GbE performance* section.
2. Set the TS bit rate value to 160.000000 Mbps as shown in the following figure.

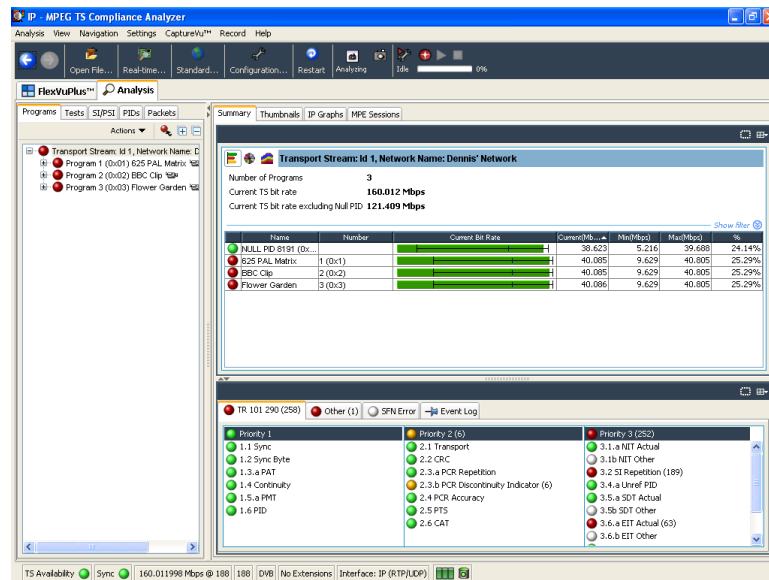


**Figure 2-21: Clock dialog box**

The status bar displays the TS bit rate as 160.000000 Mbps.



3. Perform the steps 6 through 15 listed in the *Checking Option GbE performance* section.
4. Check that the TS bit rate displayed in the status bar is approximately equal to 160.000000 Mbps as set in the MTS400P instrument.



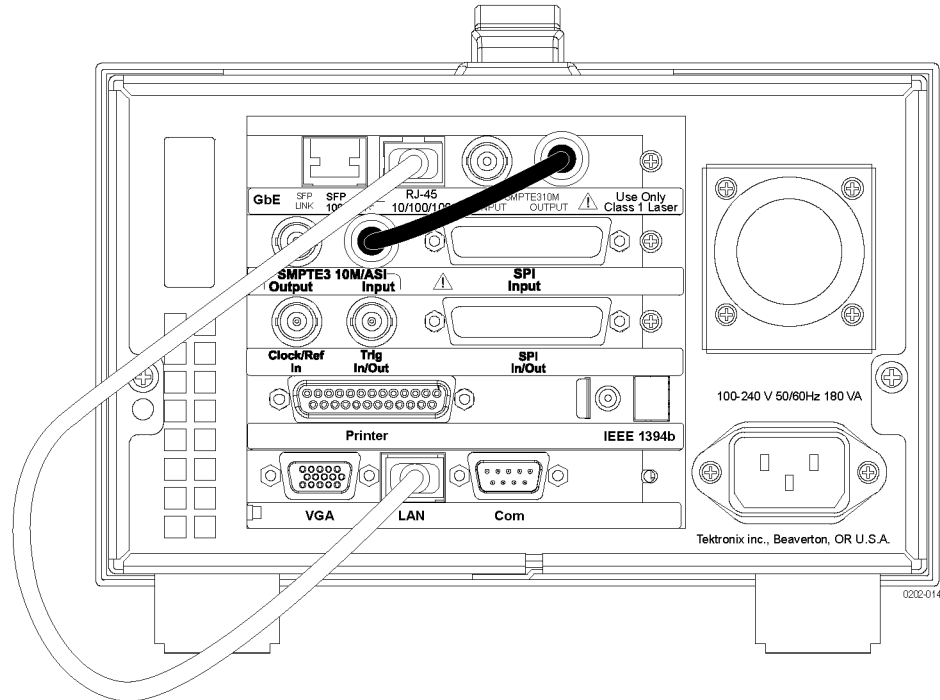
5. Disconnect the DUT MTS400P MPEG system from the test setup and turn it off using the front panel POWER switch. After the Windows shutdown completes, unplug the power cord from the system.

- 6.** Disconnect the MTS400 Series MPEG system from the test setup:
  - a.** Disconnect the cable to the SFP module.
  - b.** Remove the SFP module.
  - c.** Close all applications running on the MTS400 Series MPEG system and turn it off using the front panel POWER switch. After the Windows shutdown completes, unplug the power cord from the system.

**Option IPTVP**

Option IPTVP adds a Gigbit Ethernet interface with a RJ45 Base10/100/1000T connector. There is also provision for optional LX, SX, or ZX SFP (Small Format Pluggable) optical modules. Use this procedure to verify operation of the RJ45 connector.

1. Connect an Ethernet cable from the RJ45 connector on the rear panel to the LAN connector, as shown:



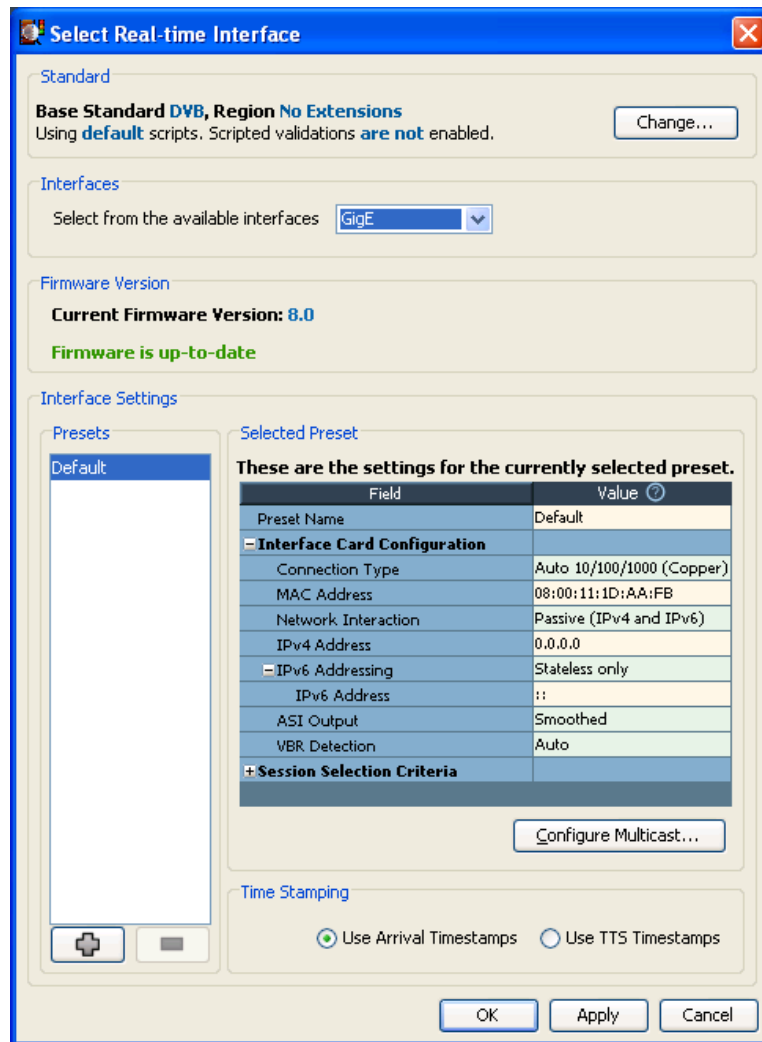
2. Launch the **TS Compliance Analyzer** application from the desktop.
3. In the TS Compliance Analyzer window, select **Real-time..** and close any dialog boxes which are open.

---

**NOTE.** The Firmware version is up-to-date. If it is not up-to-date, a message appears to update the version and the Update Firmware button is activated. Click **Update Firmware** and allow the update to complete.

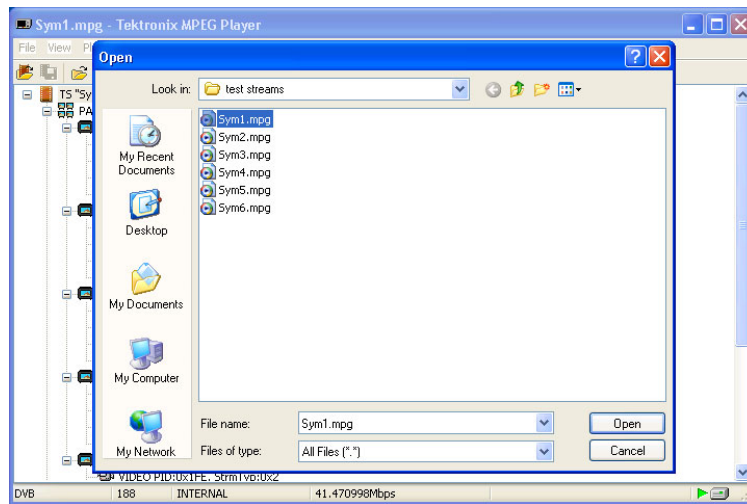
---

4. In the Select Real-time Interface window, verify that the **GigE** interface appears in the **Select from the available interface** drop-down menu.



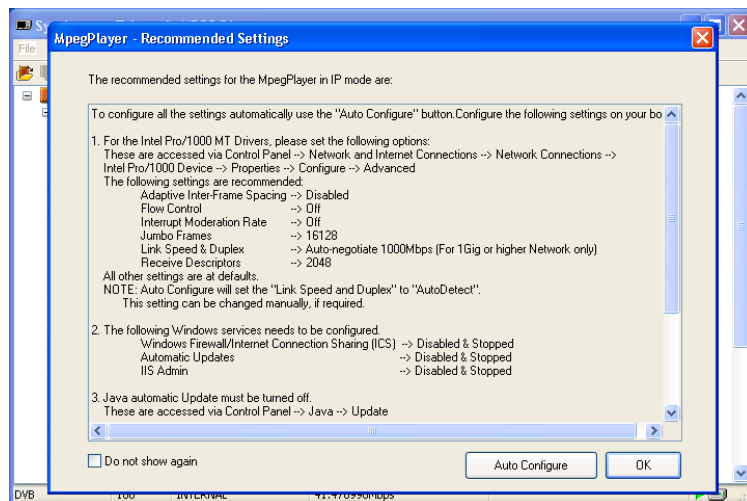
**NOTE.** If the GigE interface appears, the Interface Settings displayed should be similar to the values shown above. If you wish to proceed with the analysis, make sure that the Connection Type is set to **Auto**.

5. If you want to start the analysis and if the local setup matches the interface settings, click **OK** to close the Select Real-time Interface dialog box.
6. Click the **Interface** tab and select the **IP Tables** tab.
7. Minimize the TSCA Application. Do not close the application window.
8. Launch the MPEG Player Application.
9. Select **File > Open**, then browse to C:\test streams and select **Sym1.mpg**.



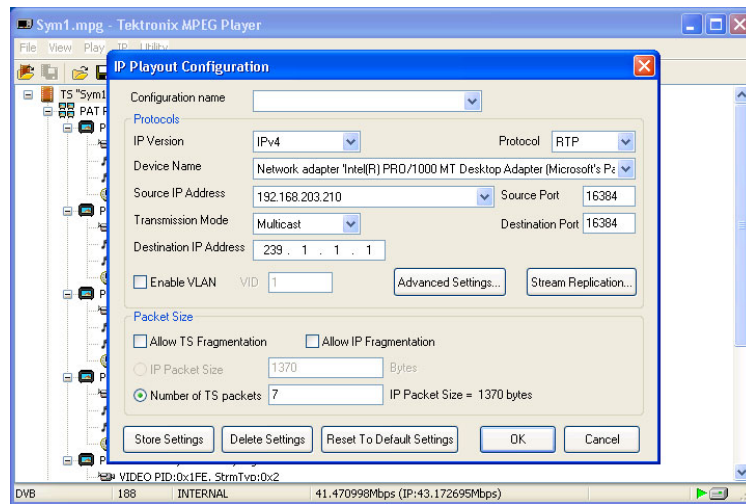
10. Select **Play > Interface > IP**.


11. If this is the first time running the IP interface, you should select “Auto Configure” on the following settings page. Otherwise, click the **OK** button.

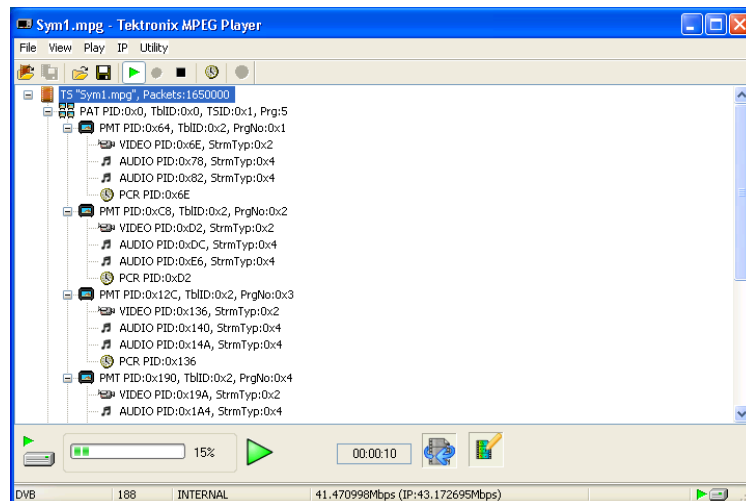


12. If Auto Configure was selected in the previous step, reboot the box and repeat steps 2 through 11 above.

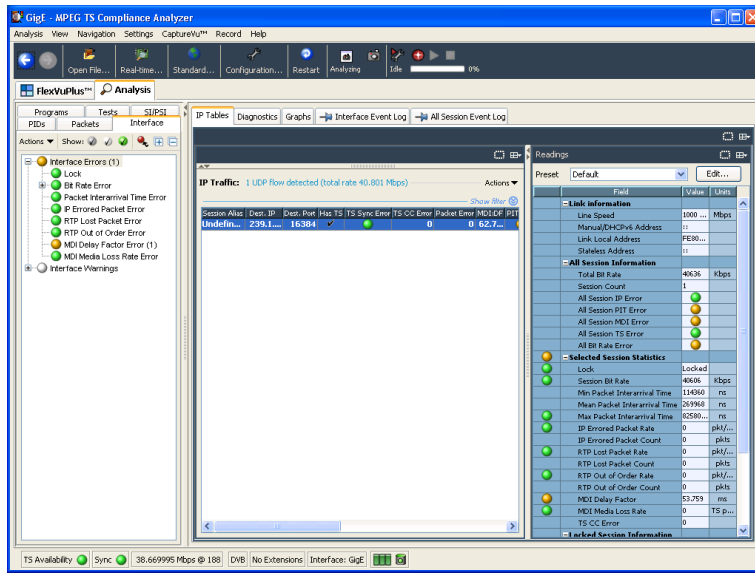
13. Select **IP > Configuration**. Set the items in the dialog box as shown in the following figure and then click the **OK** button.




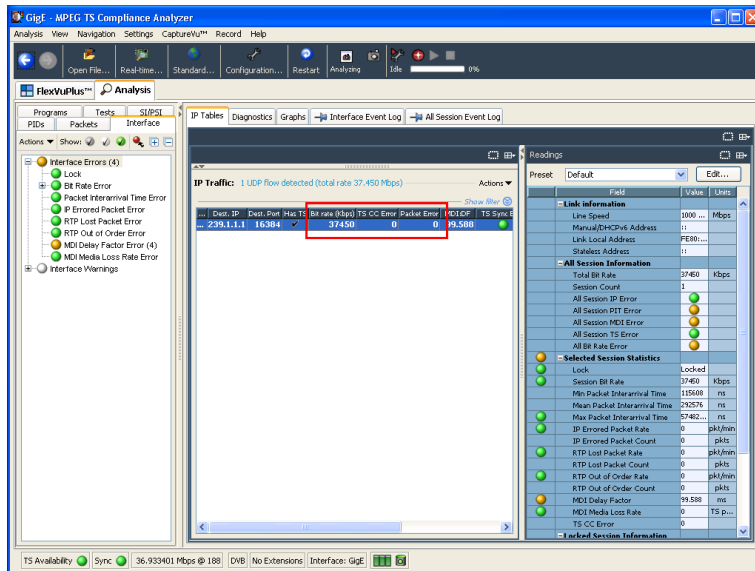
14. Start the IP packet generator by selecting the **Play** button (  ) on the MPEG Player application toolbar.
15. The following screen should appear.



16. Maximize the TSCA application (minimized in step 7) and select the generated IP session on the Traffic Table. This is done by double clicking the specific line on the table.



17. Select the **Restart Button** (  ) on the TSCA Toolbar. After restart, the TSCA analyzes the generated IP traffic. Error and limit indicators will be red, yellow, or green depending where the specific limits are set for the instrument.
18. Check that the traffic is selectable. Check that the bit rate, TS CC errors, Packet errors, and other measurements are similar to the readings in the following figure. If they are, the instrument is working correctly.



This completes the MTS400P performance verification.